

## Structure of microfiche

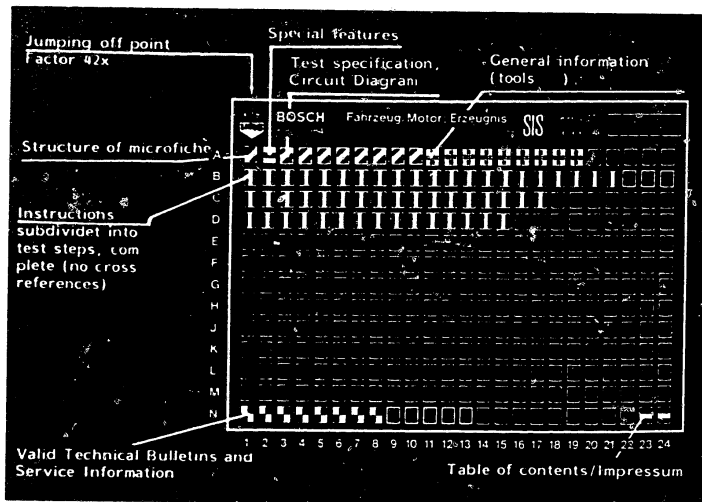

1. Read from left to right
2. Title of microfiche (appears on each coordinate)

<b>E16</b>	Product/component/test step
	Vehicle/engine

← Coordinate

3. Limits of section

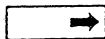

Beginning

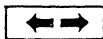

Mid-section

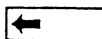

End

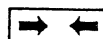

One-page section

4. References to relevant test steps in test specifications; coordinate e.g. C6

**C6**

**A1**

Trouble-shooting program



1. Special features:

K1 alternator with built-on vacuum pump  
max. vacuum 0.95 bar.

Alternator 0 120 488 001 was used in preparing these  
instructions.

**A2**

Special features

0 120 488 ..



## 2. Test specifications - electrical

### 2.1 Suppression capacitor

3.8...5.7  $\mu$ F

**B1**

### 2.2 Resistances

**B10**

**B17**

Alternators 0 120 488 ..

Stator  
 $\Omega + 10\%$

Rotor  
 $\Omega + 10\%$

000/001

K1 (RL) 14V23/65A

0.10

2.8

002/003

K1 (RL) 14V23/55A

0.14

2.9

004/005

K1 (RL) 14V20/45A

0.18

2.9

### 2.3 Regulated voltage

Regulator (EL) 1 197 311 012

Regulated voltage  
at load

13.7...14.5 V  
 $\leq 10A$

**D6**

**A3**

Test specifications - electrical

0 120 488 ..



Power test

**D6**

Warm alternator (+60°C) with regulator  
Hold regulated voltage at 13 V by loading.

Alternators  
0 120 488 ..

	Rotational speed min <sup>-1</sup>	Set load A
000/001 K1(RL) 14V23/65A	1500 2100 6000	23 44 65
002/003 K1(RL) 14V23/55A	1200 1500 6000	10 23 55
004/005 K1(RL) 14V20/45A	1250 1500 6000	10 20 45

**A4**

Test specifications - electrical  
0 120 488 ..



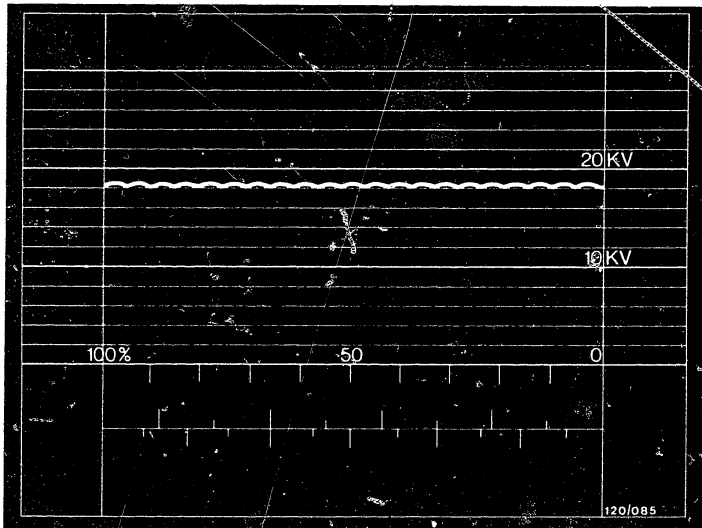

#### 2.4 Oscilloscope display OK

If the alternator is OK, the above oscilloscope pattern will be displayed. The DC output has a slight ripple. The pattern can exhibit small peaks when the voltage regulator comes into operation. The regulator can be stopped by means of switching in loads (e.g. load resistor).

Adjust the pattern height so that the ripple is contained between two adjacent kV lines.

In order to be able to compare such patterns, the pattern concerned is to be adjusted with the vertical control of the oscilloscope so that it fits approximately between the 10 kV and 20 kV lines.

Note: more than one defect can be present at one time.

**A5**

Test specifications - electrical

0 120 488 ..



### 3. Test specifications - mechanical

#### True-running error

O.D. of rotor	0.05 mm
O.D. of collector rings	0.03 mm

---

Min. dia of collector rings	26.8 mm
	new 27.8 mm

---

**B20**

#### Minimum projection of brushes

with EL regulator 1 197 311	0.. 5.0 mm
	new 12...13 mm

---

**B3**

#### Vacuum

P max =	0.95 bar
---------	----------

---

**D5****A6**

Test specifications - mechanical  
Q 120 488 ..



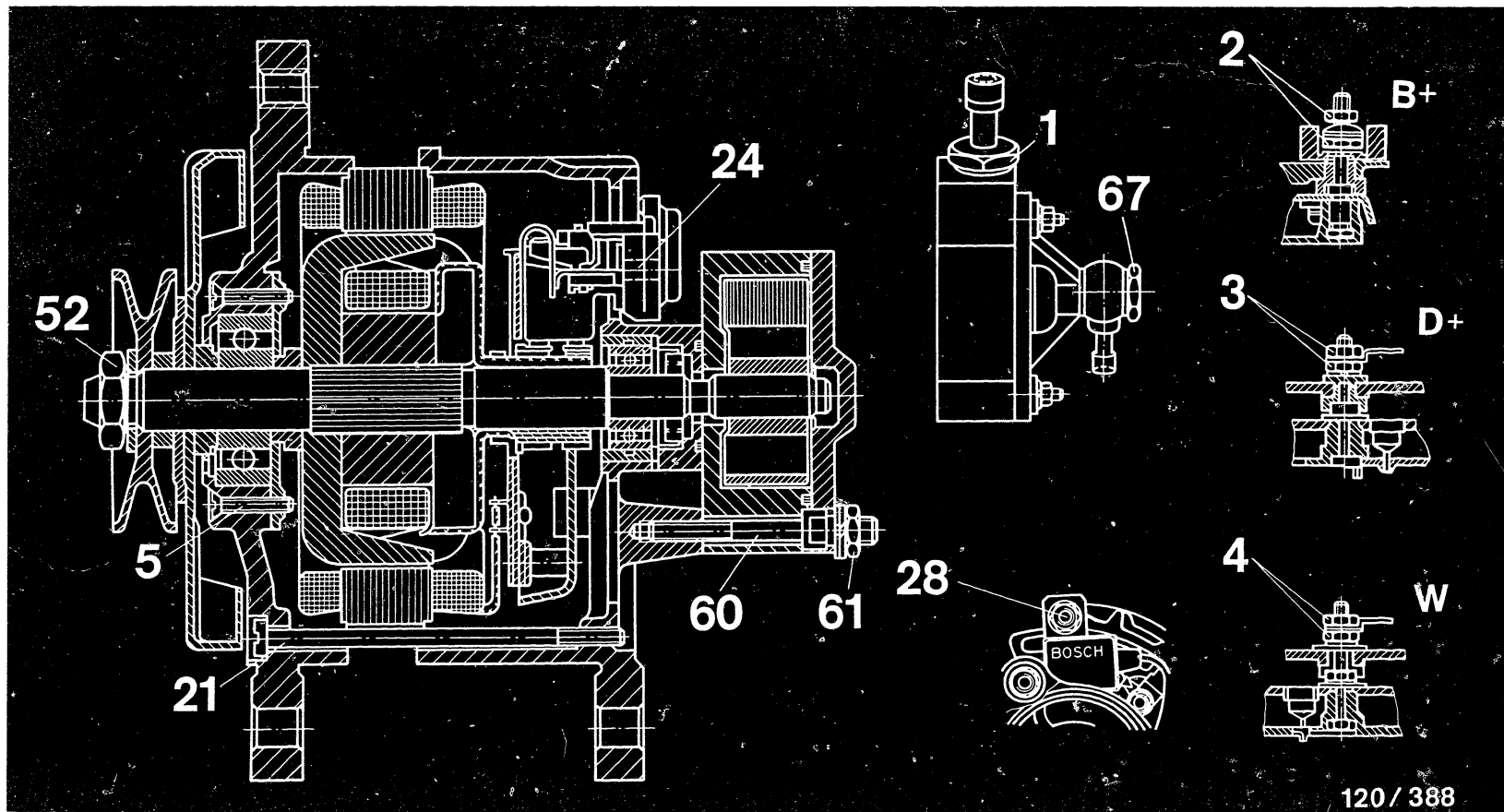

120 / 388

3.1 Tightening torques:

Item 1 = 35...40 Nm  
 Item 2 = 4.8...6.8 Nm (B+)  
 Item 3 = 1.6...2.3 Nm (D+)  
 Item 4 = 1.6...2.3 Nm (W)  
 Item 5 = 2.4...3.5 Nm

Item 14 = 1.4...2.0 Nm (Rectifier mounting)  
 Item 21 = 4.1...5.5 Nm  
 Item 24 = 1.6...2.3 Nm  
 Item 28 = 4.5...5.5 Nm

Item 52 = 35 ... 45 Nm  
 Item 60 = 6 ... 7 Nm  
 Item 61 = 4.5...5.5 Nm  
 Item 67 = 25 ...30 Nm

**A7**

Test specifications - mechanical  
 0 120 488 ..



**A8**

Test specifications - mechanical  
 0 120 488 ..



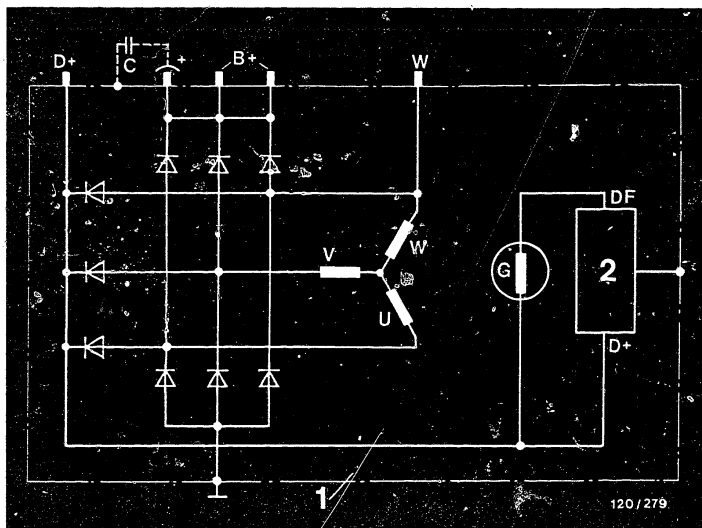

- 1 = Alternator  
 2 = Attached-type regulator

4. Circuit diagram of K1 alternator 0 120 488 .. up to 65A with terminal W and attached-type regulator

**A9**

Circuit Diagram

0 120 488 ..





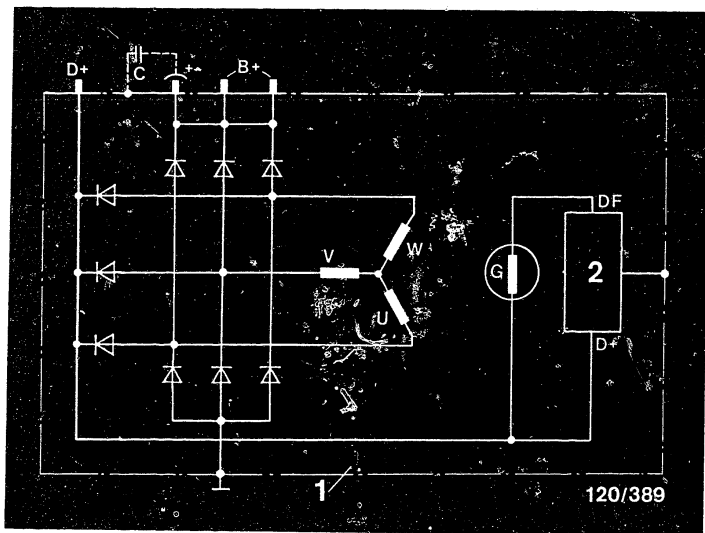

- 1 = Alternator  
 2 = Attached-type regulator

Circuit diagram of K1 alternator 0 120 488 .. up to 65A  
 without terminal W and attached-type regulator

## 5. General information

Explanation of type code of generator (old)

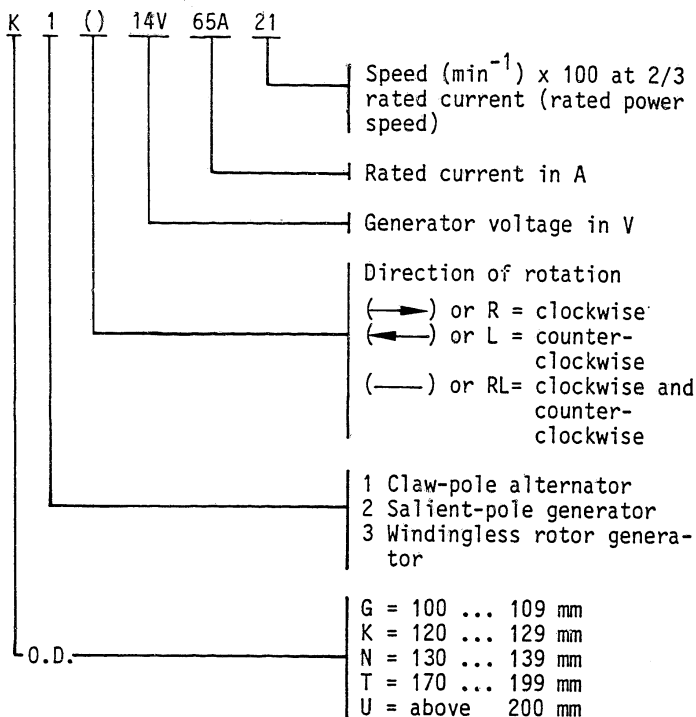

**A11**

General information

0 120 488 ..



Explanation of type code on generator (new)  
as of beginning of 1983

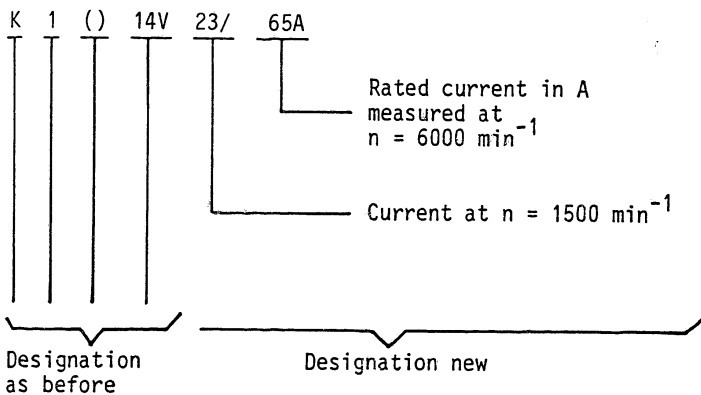

## 5.1 Cleaning the parts

**CAUTION! FIRE HAZARD!**

Alternators are being increasingly fitted with long-storage capacitors (e.g. for the interference suppression of receivers and transmitters).

When washing parts of the alternator it is possible for the capacitor to discharge when immersed in cleaning fluids, there then being the danger that inflammable liquids will ignite. For this reason, parts with capacitors must only be washed in tri- or perchloro-ethylene.

### Note:

Alternator 0 120 488 001 was used in preparing these repair instructions.

The various versions of alternator should be taken from the corresponding service-part microfiches.

**A13**

General information

0 120 488 ..



## 6. Test equipment, tools and adhesives

### 6.1 Test equipment

Generator test bench	EFLI 91	0 683 300 100
	or EFLJ 70A	0 680 104 ..

For additional inspection  
or test:

Ignition oscilloscope (all versions)

or

Bosch motortester (all versions)

Electrics tester	ETE 014.00	0 684 101 400
------------------	------------	---------------

Vacuum tester	ETT 007.00	0 684 100 700
---------------	------------	---------------

**A14**

Test equipment and tools

0 120 488 ..



Test equipment (continued)

Test panel	EFAW 81 or KDAW 9984	0 681 169 013
Transformer panel	EFAW 82 or KDAW 9985	0 681 169 014
Insulation test- er or test prods	EFAW 84 KDAW 9983	(Included with EFAW 81 or KDAW 9984)
Dial indicator	EFAW 7	1 687 233 011
Magnetic instrument stand	T-M1 (EW/MS 1 B 1	4 851 601 124 0 601 980 001)
Alternator tester	EFAW 192 or WPG 012.00	0 681 101 403 0 684 201 200
3 Feeler gauges 0.15 ... 0.6 mm	KDZV 7399	
Vacuum reservoir obtainable from Bitzer GmbH & Co KG Postfach 240 7032 Sindelfingen		FS30 (approx. 3 l) (order with dummy plug on connection "K1.")



## 6.2 Tools

Press-in mandrel for radial seal	KDLI 6026
Press-on mandrel for collector rings	KDLI 6027
Press-on mandrel for rotor	KDLI 6002
Holding device for pulley	KDLI 6006
Clamping pin for arbor press	KDLI 6010
Press-on mandrel for collector-ring end shield	KDLI 6028
Mounting sleeve	KDLI 6025
Clamping support	KDAW 9999
Arbor press	(commercially available)
Two vee blocks	(commercially available)
Soldering iron 180 W	(commercially available)
Puller for collector rings	(commercially available)
Drift	(commercially available)
Press-out ring e.g. old starting-motor housing, I.D. 105 mm O.D. 115 mm	



### 6.3 Adhesives

Locking paint "precote 80"

obtainable from:

S c h r a u s i  
Schraubensich. Gesellschaft  
Schlosserstraße 1

7000 S t u t t g a r t 1

**A17**

Adhesives

0 120 488 ..





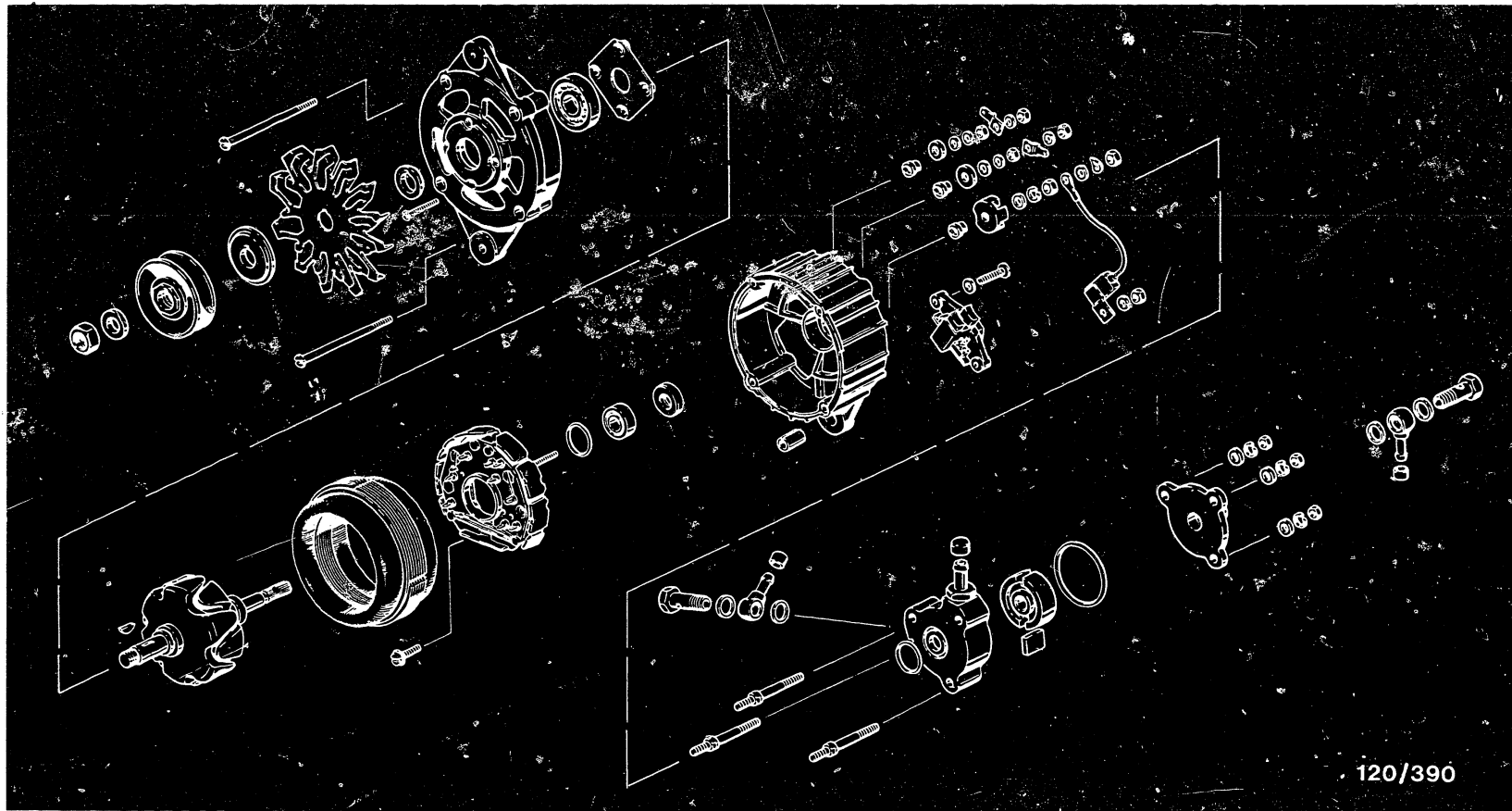

120/390

7. Exploded view of alternator 0 120 488 001 with vacuum pump

**A18**

Exploded view  
0 120 488 ..



**A19**

Exploded view  
0 120 488 ..



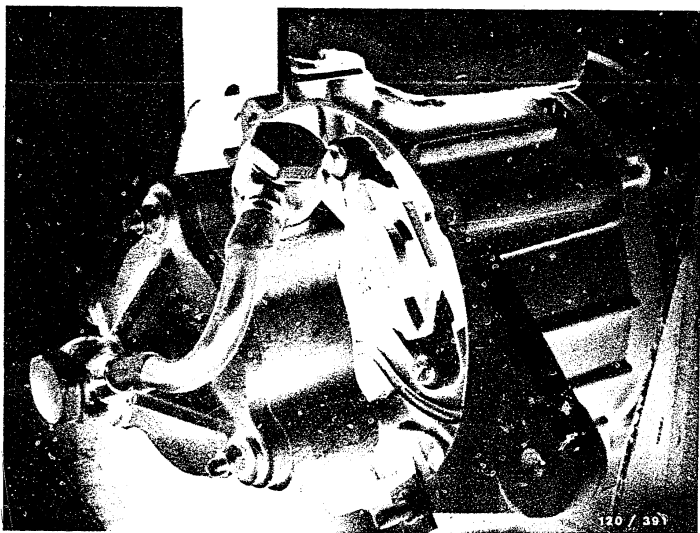

## 8. Dismantling the alternator and checking the parts

Clamp alternator in clamping support KDAW 9999.

### 8.1 Testing the suppression capacitor (not shown)

Undo the lead of the suppression capacitor from B+ terminal stud. Connect electric tester between lead of suppression capacitor and terminal B- of alternator (not shown). Specified value: 1.8 ... 2.6  $\mu\text{F}$ .

If specified value is not reached, replace defective suppression capacitor. After testing, discharge suppression capacitor by short-circuiting so that there is no possibility of the cleaning fluid being ignited when cleaning the parts.

**B1**

Dismantling the alternator

0 120 488 ..



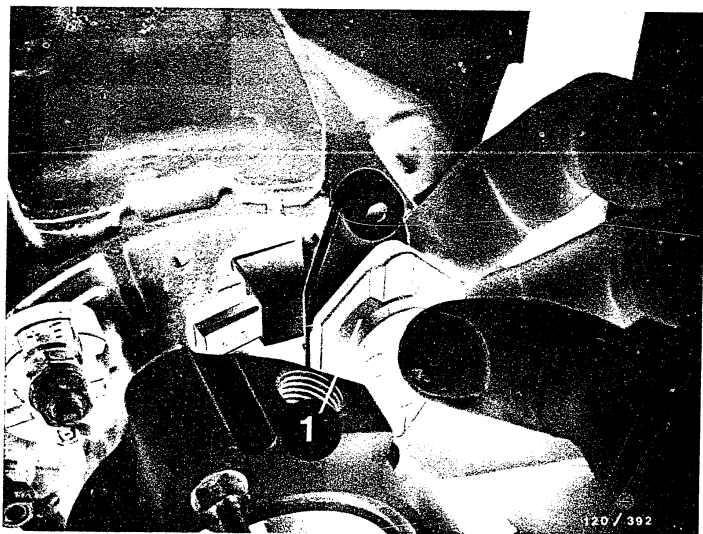

1 = Electronic regulator with carbon-brush holder

Caution!

Before further dismantling the alternator, first of all remove the electronic regulator.

To do this, unscrew the 2 fastening screws on the regulator.

If the pump housing has also to be removed, it is easier to remove the regulator after removing the pump housing.

Turn regulator so that carbon brushes can be seen in the recess in the collector-ring end shield.

If dismantling sequence is not adhered to, the carbon brushes will break when the alternator is pulled apart.

**B2**

Dismantling the alternator

0 120 488 ..



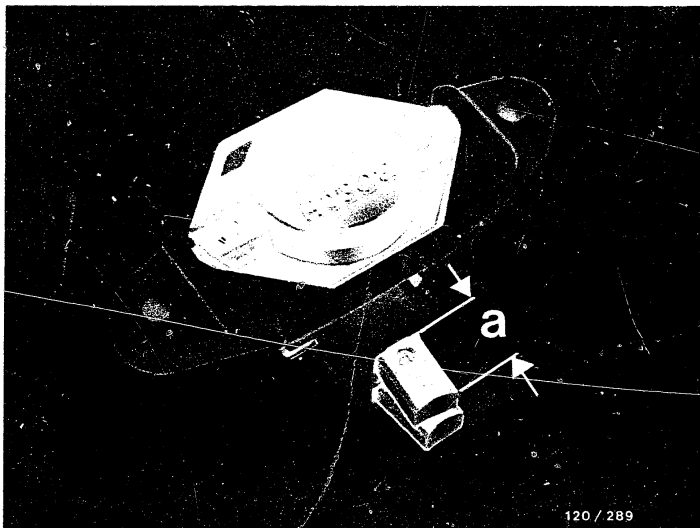

### 8.2 Checking the regulator for external damage and replacing the carbon brushes

If carbon brushes are broken off or if the projection dimension "a" is only 5 mm, replace the carbon brushes. Observe dimension "a" when soldering in the new carbon brushes.

Note:

Use only genuine carbon brushes (oil-resistant) as per service-parts list.

**B3**

Dismantling the alternator

0 120 488



Alternators 0 120 488 ..	Collector ring dia (mm)	Brush projection (mm)	
		new	min.
with EL regulator 1 197 311 0..	27.8	12...13	5.0

Note:

Solder (colophonium tin only) must not flow into copper strand.

After installing, check carbon brush for freedom of movement.

**B4**

Dismantling the alternator

0 120 488 ..



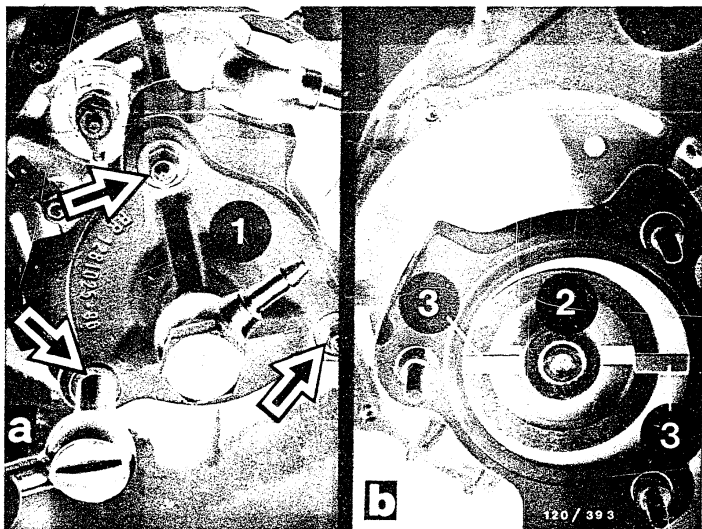

- 1 = Vacuum pump
- 2 = Rotor
- 3 = Sliders

Remove pump housing.  
Remove three self-locking nuts (arrow, picture a) and  
take off pump housing cover.  
Remove rotor and sliders (picture b).

**B5**

Dismantling the alternator  
0 120 488 ..



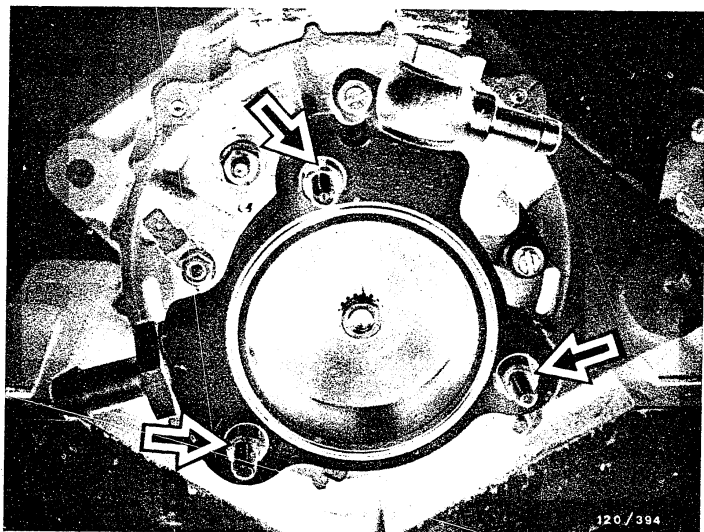

Remove three threaded pins (arrows) and take off housing.

**B6**

Dismantling the alternator  
0 120 488 ..



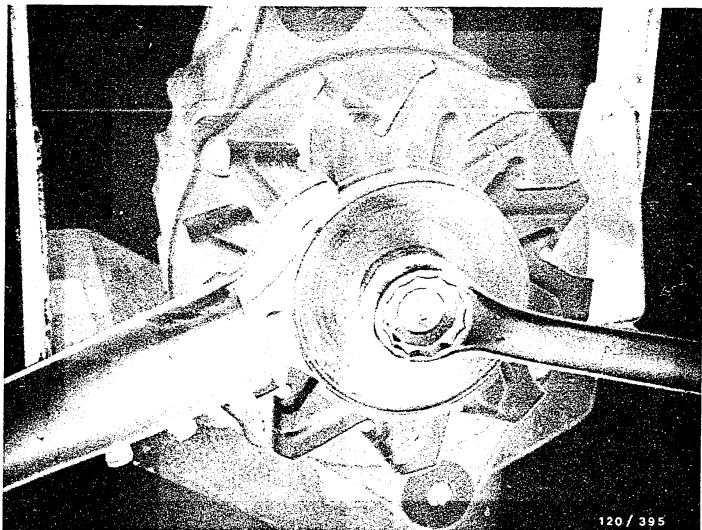

Using holding tool KDLI 6006 and 22 mm open-end wrench, loosen fastening nut and remove pulley with fan.

Note:

Discard the old fan when assembling.  
Install a new part.

**B7**

Dismantling the alternator

0 120 488 ..

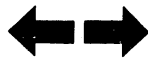



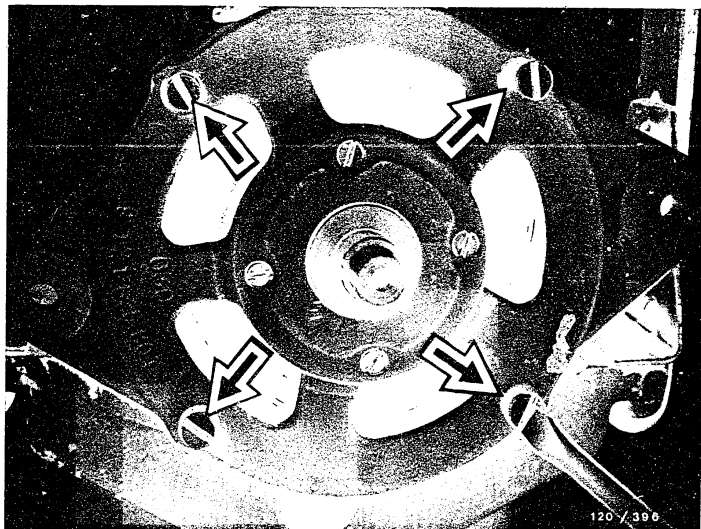

Before the alternator is further dismantled, mark the drive end shield, collector-ring end shield and stator so that these parts are brought into the same position again when assembling.

Note:

Make marks so that the longest through-bolt is also marked.

Loosen four fillister-head screws (arrows) and remove. Withdraw drive end shield with rotor from collector-ring end shield.

**B8**

Dismantling the alternator

0 120 488 ..



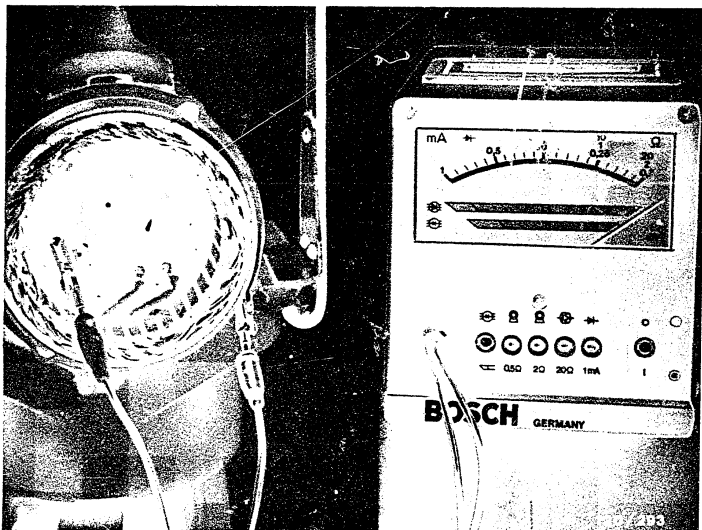

### 8.3 Testing the rectifier

Test the proper operation of the rectifier when connected up using EFAW 192 or WPG 012.00. Capacitor not connected. Note switch position on tester.

Test points:

Housing and winding ends

B+ and winding ends

D+ and winding ends

Rectifier is OK if the pointer of the tester is in the green area when testing.

If one or more diodes are defective, replace the complete rectifier.



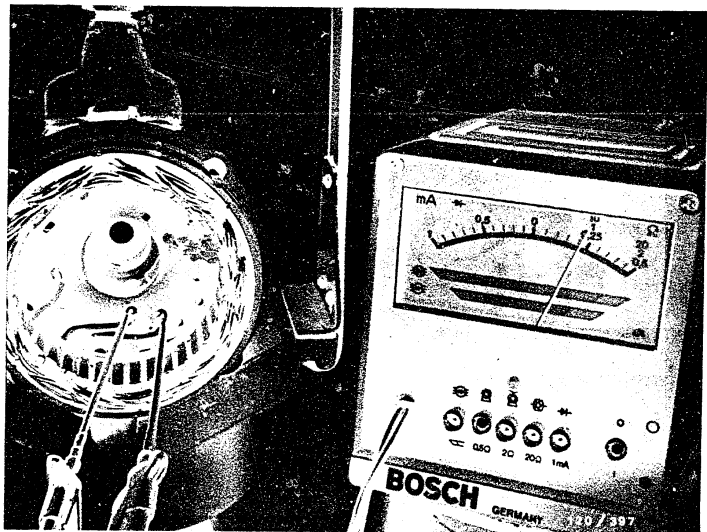

#### 8.4 Testing the stator (resistance)

Test the resistance of the stator while installed (see picture). Note switch position on tester.

Alternator	Resistance value
0 120 488 ..	Stator $\Omega + 10\%$
000/001 K1(RL) 14V23/65A	0.10
002/003 K1(RL) 14V23/55A	0.14
004/005 K1(RL) 14V20/45A	0.18

**B10**

Dismantling the alternator

0 120 488 ..



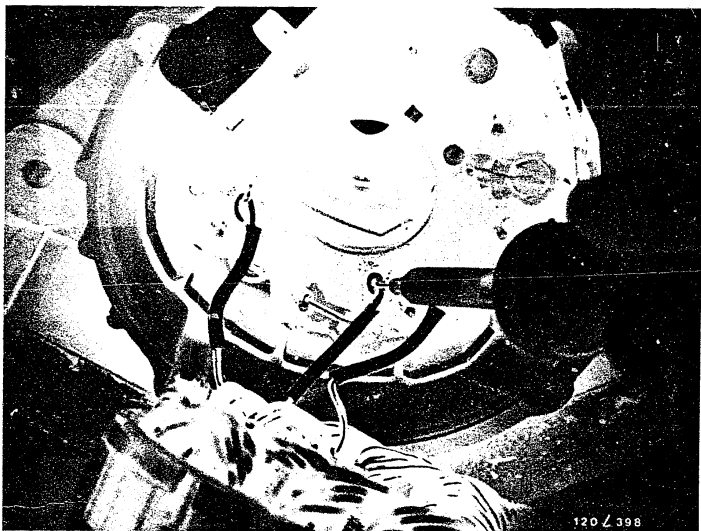

### Removing the stator

Remove solder from the phase connections using a solder extractor. Using a screwdriver, bend up the bent-over lead connections and withdraw leads from the mounting eyes.

#### Note:

When bending back the leads, do not damage the rectifier with the screwdriver.

**B11**

Dismantling the alternator

0 120 488 ..



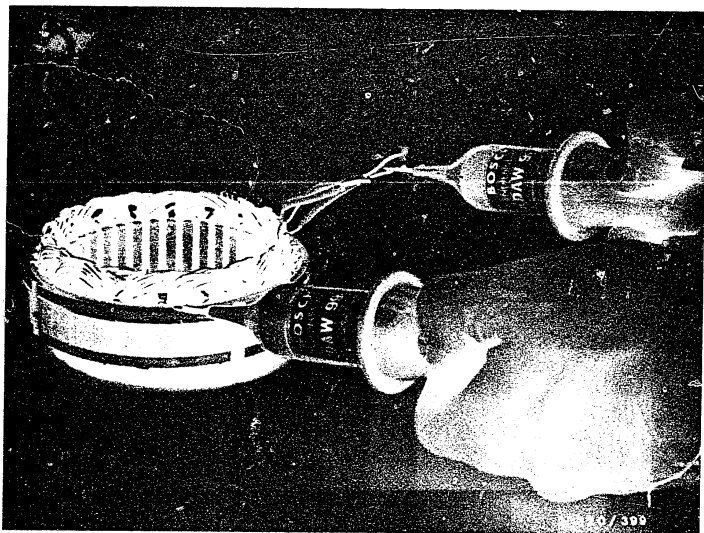

### 8.5 Testing the stator (short circuit to ground)

Test the stator for short circuit to ground using test prods EFAW 84 or KDAW 9983. (See picture).  
Test voltage: 80 V a.c.

**B12**

Dismantling the alternator

0 120 488 ..



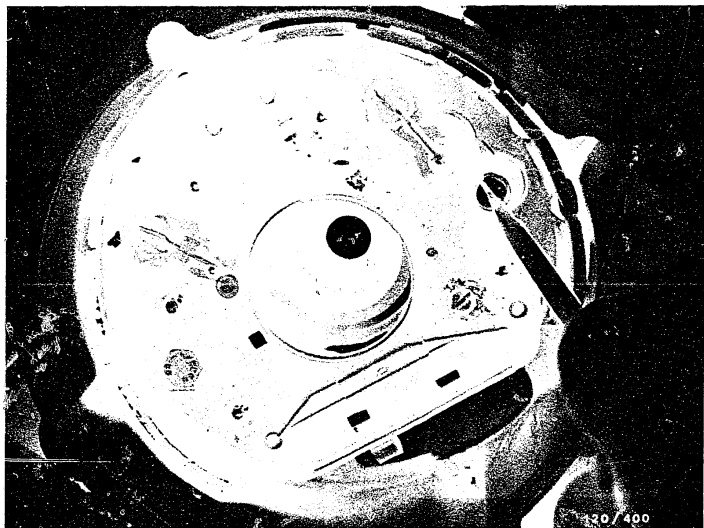

### Removing the rectifier

Remove 1 washer-and-screw assemblies on inside of rectifier (picture).

Loosen terminal studs B+ and D+ on outside of collector-ring end shield. They are rigidly mounted on the rectifier

If fitted also loosen terminal W.

Withdraw rectifier from collector-ring end shield.

**B13**

Dismantling the alternator

0 120 488 ..



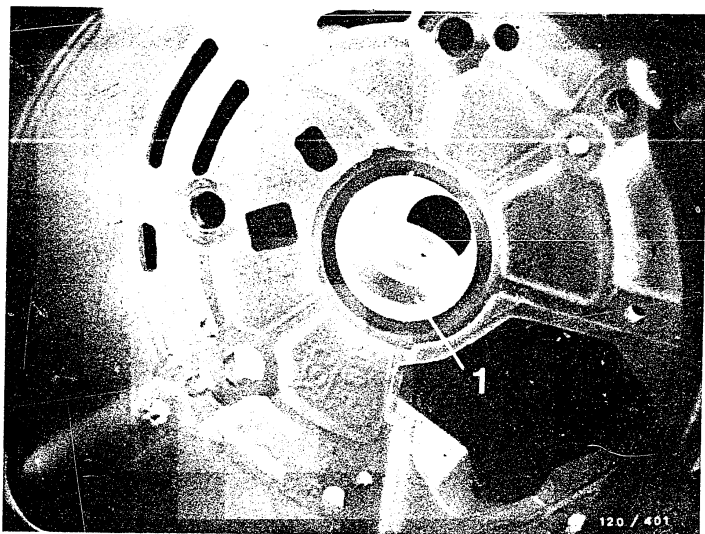

1 = Radial seal

Replacing the radial seal in the collector-ring  
end shield

Using a screwdriver, knock the radial seal out of the  
collector-ring end shield.

**B14**

Dismantling the alternator

0 120 488 ..



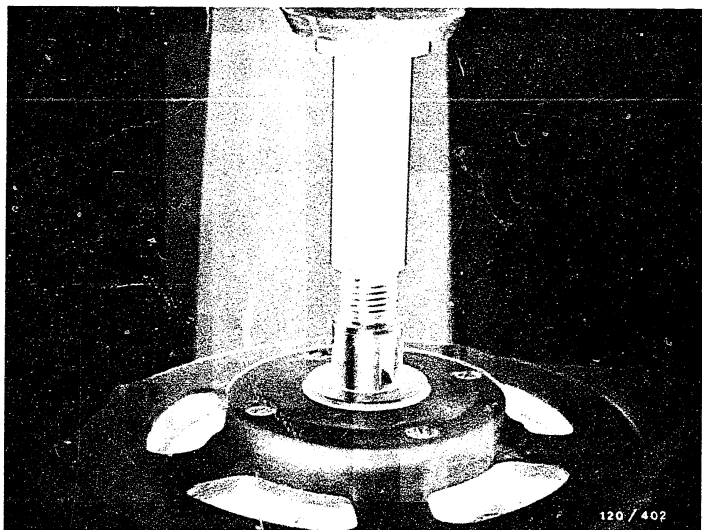

### Removing the claw-pole rotor

The claw-pole rotor need only be pressed out if the collector rings, excitation winding or deep-groove ball bearing/collector-ring ball bearing are defective. Press out drive end shield with claw-pole rotor with KDLI 6015 in conjunction with KDLI 6010 (see picture).

**B 15**

Dismantling the alternator

0 120 488 ..





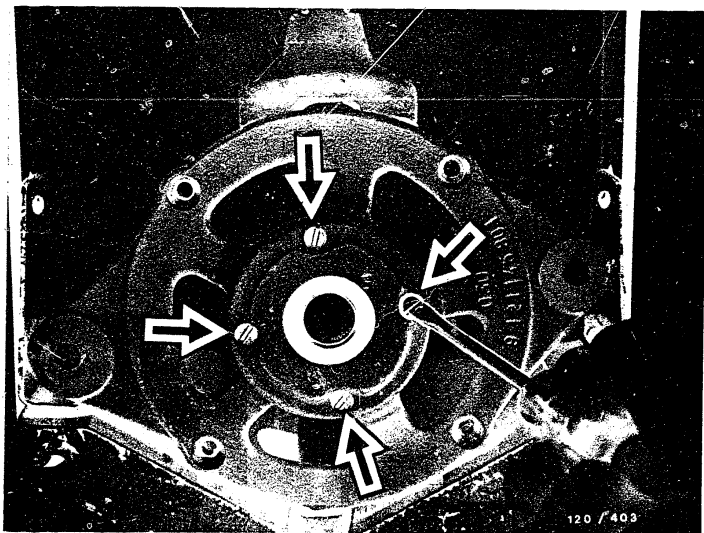

### Removing the drive end shield

Loosen four fillister-head screws (arrows). Remove cover plate from rear side and remove cylindrical-roller bearing from bearing seat (sliding fit).

**B 16**

Dismantling the alternator

0 120 488 ..



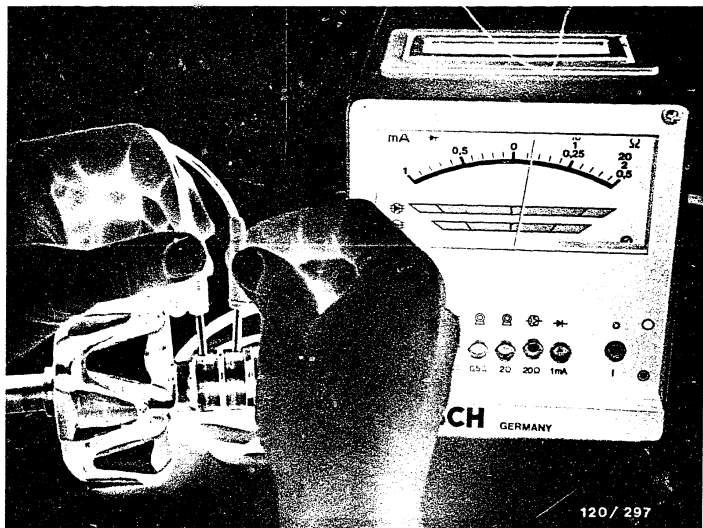

### 8.6 Testing the rotor resistance

Measure the rotor resistance using alternator tester WPG 012.00 or electric's tester ETE 014.00 (see picture).

Alternator	Resistance value
0 120 488 ..	Rotor $\Omega + 10\%$
000/001 K1(RL) 14V23/65A	2.8
002/003 K1(RL) 14V23/55A	2.9
004/005 K1(RL) 14V20/45A	2.9

**B17**

Dismantling the alternator

0 120 488 ..



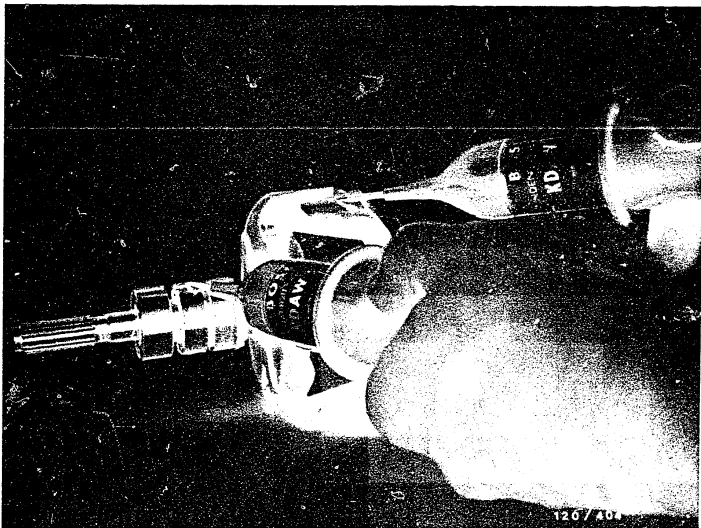

### 8.7 Testing the rotor for short circuit to ground

Test the rotor for a short circuit to ground using test prods EFAW 84. or KDAW 9983.  
Test voltage 80 V AC.

**B18**

Dismantling the alternator

0 120 488 ..

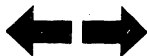

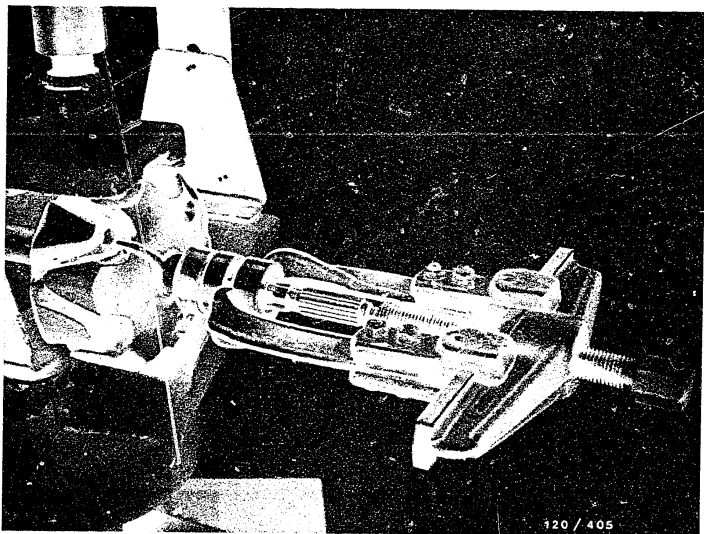

Removing the deep-groove ball bearing on the collector-ring end

Remove the deep-groove ball bearing using a commercially available puller (see picture).

**B 19**

Dismantling the alternator

0 120 488 ..



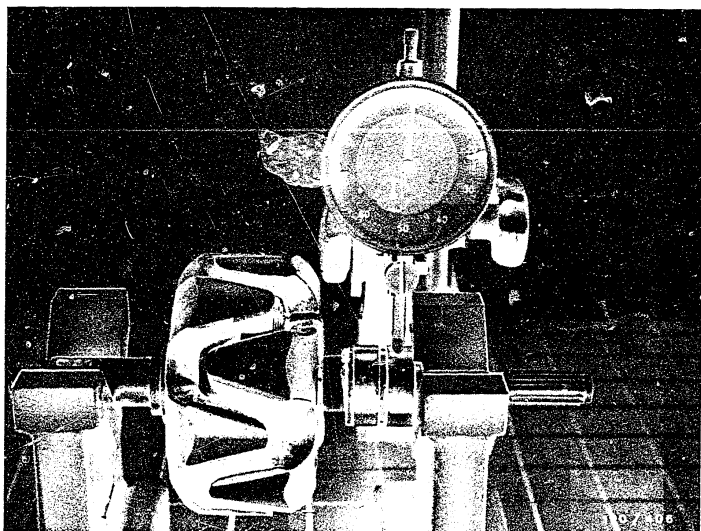

### 8.8 True-running test

Mount the journals of the rotor in the V-supports and align exactly horizontal. Carry out true-running test on outside diameter of rotor (see picture) and on outside diameter of the collector rings (arrows) using magnetic instrument stand T-M1 (4 851 601 124) and dial indicator EFAW 7.

Maximum error on rotor 0.5 mm.

Maximum error on collector rings 0.03 mm.

If error is greater, skim collector rings.

Minimum diameter of collector rings:

Alternator	Collector ring dia. (mm)	
	new	min. dia.
0 120 488 ..	27.8	26.8

**B20**

Dismantling of alternator

0 120 488 ..



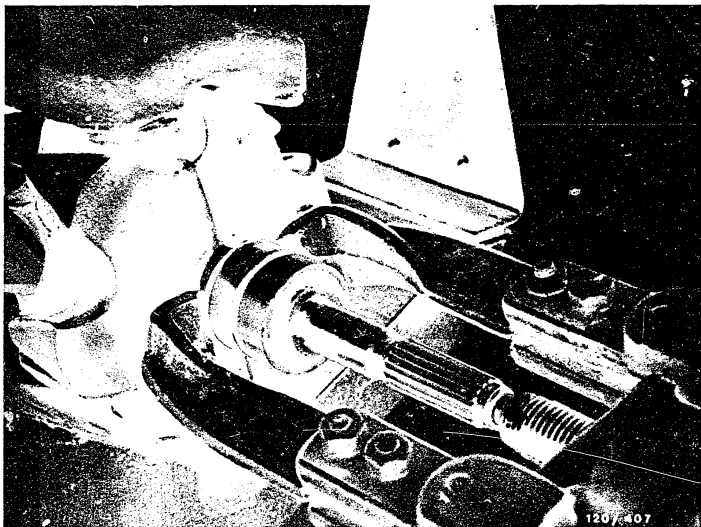

### Removing the collector rings

Unsolder leads of excitation winding from the collector rings.

Using commercially available puller, remove the collector rings from the rotor shaft (not shown).

**B21**

Dismantling the alternator

0 120 488 ..



## 9. Cleaning the parts

**CAUTION! FIRE HAZARD!**

Alternators are being increasingly fitted with long-storage capacitors (e.g. for the interference suppression of receivers and transmitters).

When washing parts of the alternator it is possible for the capacitor to discharge when immersed in cleaning fluids, there then being the danger that inflammable liquids will ignite. For this reason, parts with capacitors must only be washed in tri- or perchloroethylene.

**C1**

Cleaning the parts

0 120 488 ..



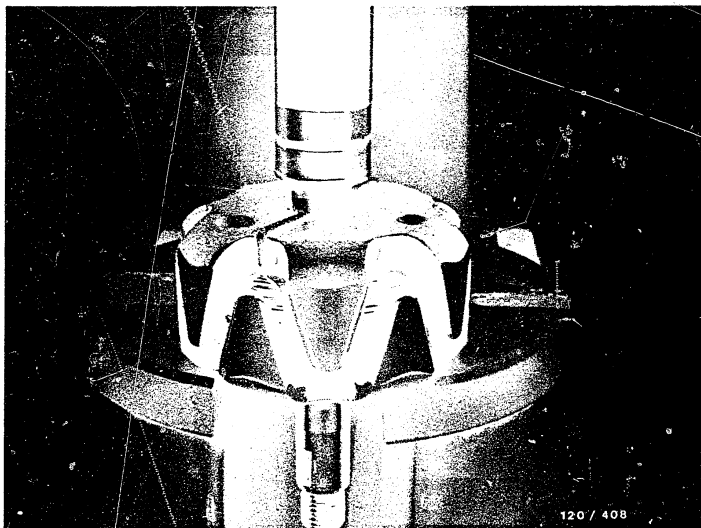

## 10. Assembling the alternator

### Pressing on the collector rings

Place the collector rings on the rotor shaft. Introduce one lead from the excitation winding into the groove in the collector rings. Then press on collector rings as far as they will go using press-on tool KDLI 6027. When doing this, position the groove of the press-on tool so that the lead of the excitation winding which is guided through the collector rings is visible.

Solder the wire leads of the excitation winding. Turn down the soldered joint on both collector rings until the collector rings are no longer uneven.

**G2**

Assembling the alternator

0 120 488 ..





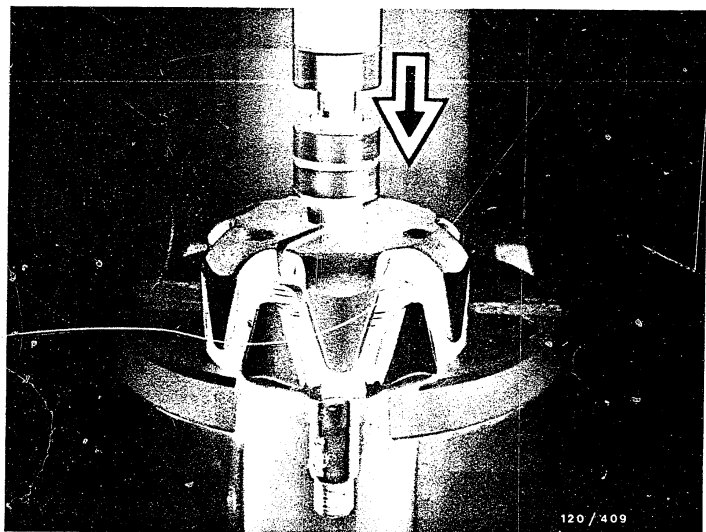

Pressing on the deep-groove ball bearing on the collector-ring end

Place a new deep-groove ball bearing on the rotor shaft and press on as far as it will go under an arbor press using press-on tool KDLI 6028 (see picture).

**C3**

Assembling the alternator

0 120 488 ..



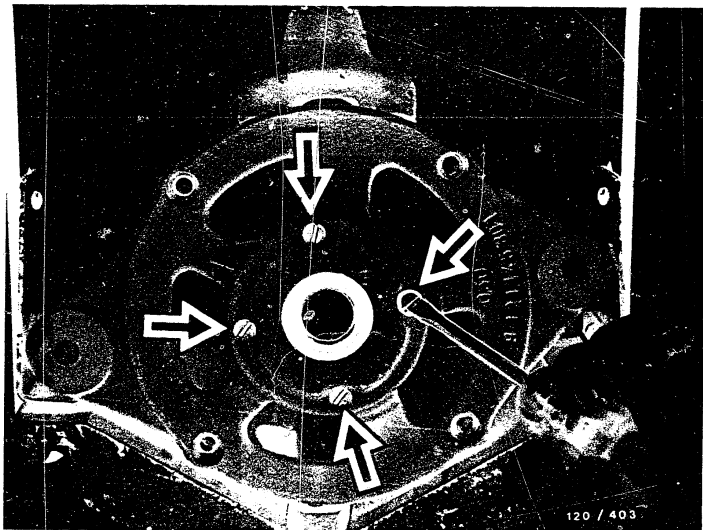

Assembling the drive-end-bearing housing if holding plate is screwed from outside:

Introduce a new deep-groove ball bearing into the drive-end-bearing housing.

Position new holding plate and fasten with 4 screws (see picture), tightening cross-wise to a tightening torque of 2.4...2.9 Nm.

**C4**

Assembling the alternator

0 120 488 ..



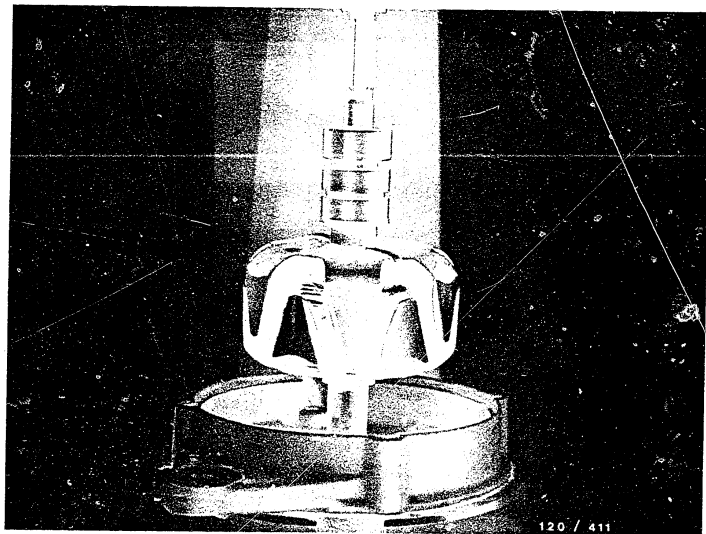

### Pressing the rotor into the drive-end-bearing housing

Place spacer ring right side up on a suitable surface so that it is fully supported. Place the drive-end-bearing housing over the spacer ring with its outside pointing downwards.

Introduce the rotor into the drive-end-bearing housing (see picture).

Clamp press-on tool KDLI 6002 into the arbor press and press the rotor into the drive-end-bearing housing as far as it will go.

**C5**

Assembling the alternator

0 120 488 ..



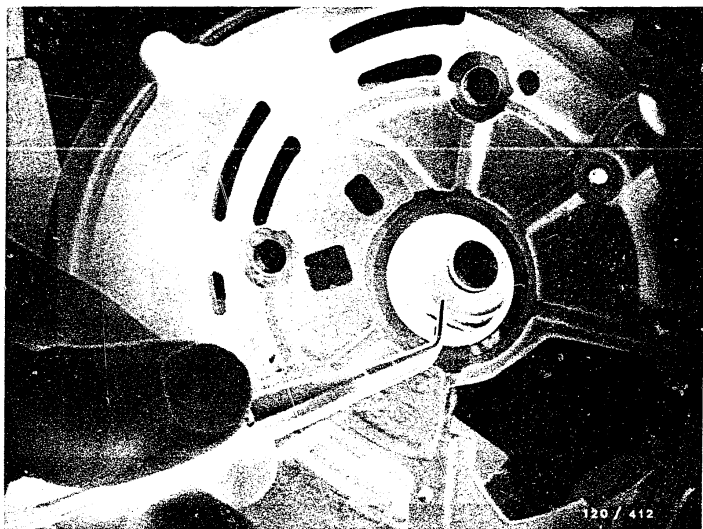

Replacing the O-ring in the collector-ring end shield

Check the O-ring for damage and replace if necessary.

**C6**

Assembling the alternator

0 120 488 ..



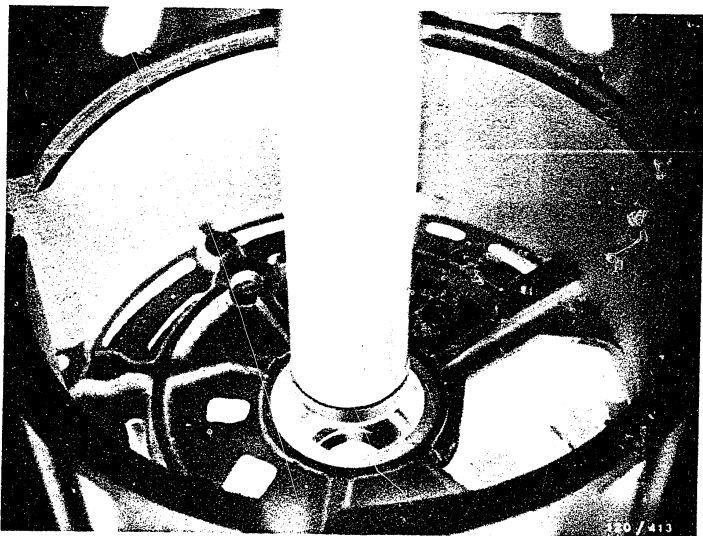

Replacing radial seal in collector-ring end shield

Fit radial seal, right way round, onto press-in tool KDLJ 6026 and press into collector-ring end shield.

Note:

Do not damage radial seal since otherwise there will be no guarantee of proper sealing between pump and alternator.

**C7**

Assembling the alternator

0 120 488 ..



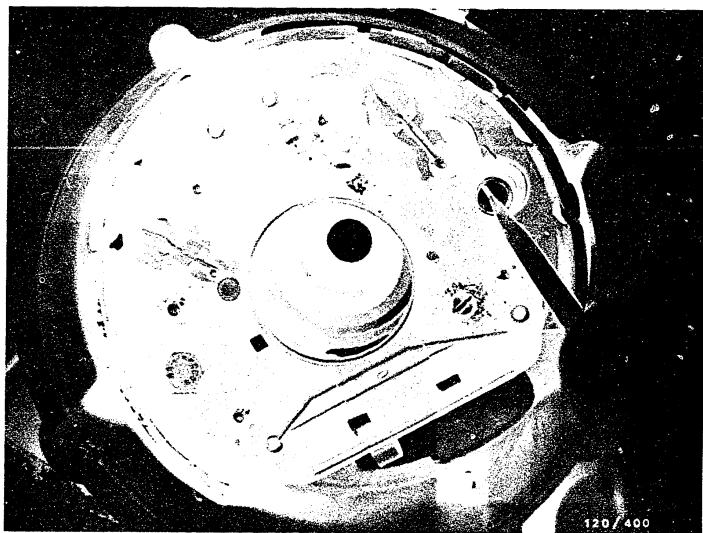

### Installing the rectifier

Fit insulating bushings over terminal studs B+, D+ (W, if applicable). Introduce rectifier into collector-ring end shield and secure with fillister-head screw. Tightening torque: 1.4...2.0 Nm.

**C8**

Assembling the alternator

0 120 488 ..



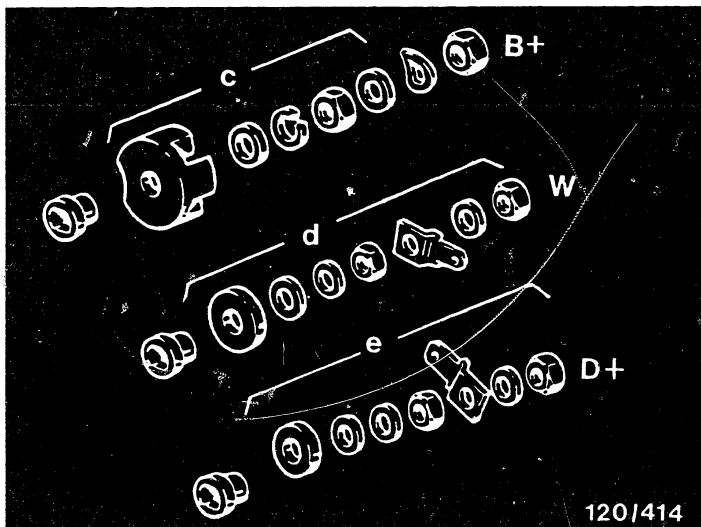

120/414

Fasten the rectifier at the terminal end using parts c, d, e (if available).

Tightening torques:

Part c = 4.8 ...6.8 Nm

Part d = 4.8 ...6.8 Nm

Part e = 1.6 ...2.3 Nm



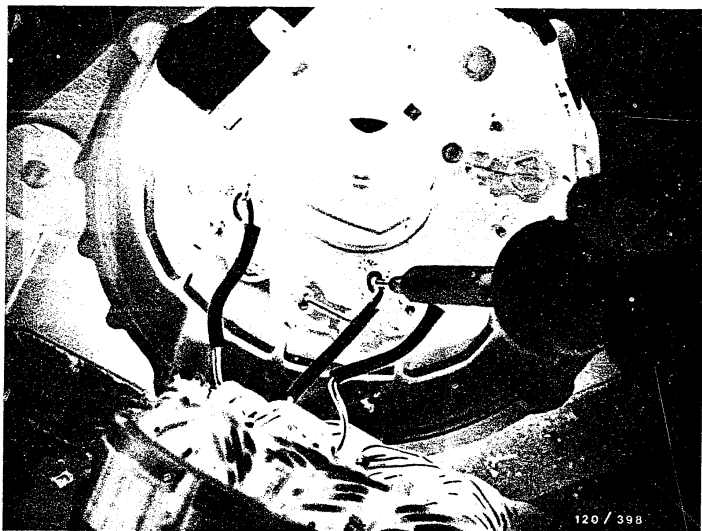

### Fitting the stator and the rotor

Place the stator against the rectifier bearing. Bring the markings on the collector-ring end shield and stator (made before dismantling the alternator) into alignment.

Solder on the connection wires of the stator (see picture). When doing this, make sure that the connection wires will not afterwards touch against the rotor.

**C10**

Assembling the alternator

0 120 488 ..





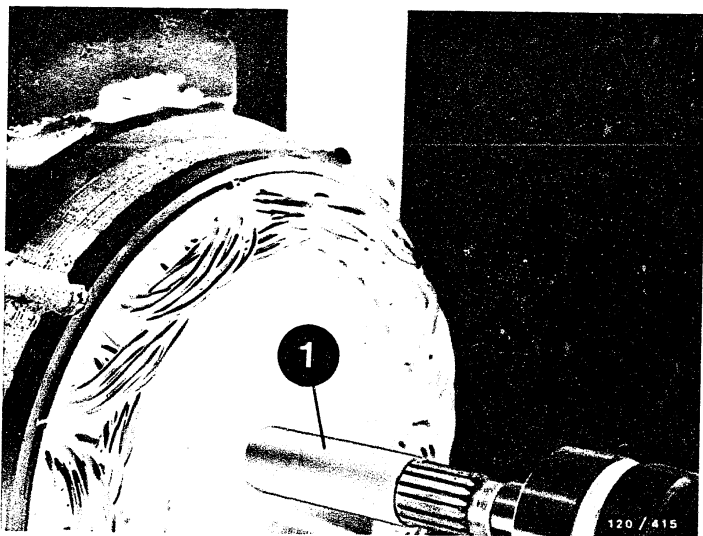

1 = Mounting sleeve

Introducing the rotor into the collector-ring end shield

Slide mounting sleeve KDLJ 6025 over toothed shaft.

Note:

The radial seal at the collector-ring end will be damaged when assembling if the mounting sleeve is not used.

Carefully introduce rotor into collector-ring end shield. Bring marks on housing into alignment.



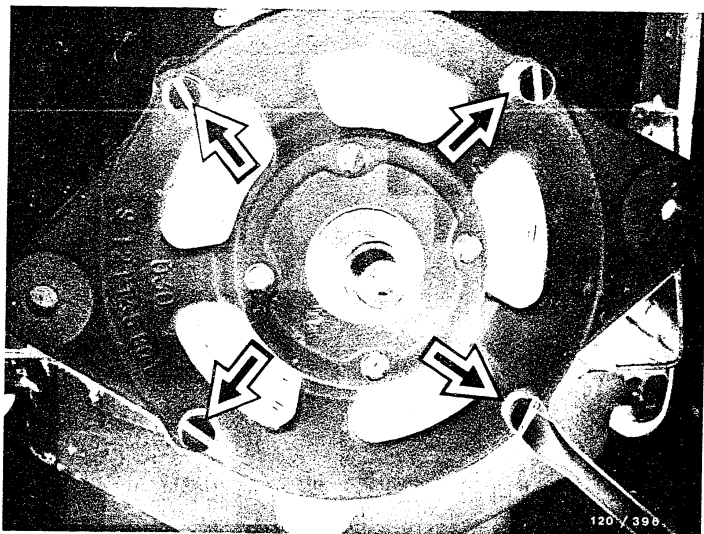

Screwing together the drive-end-bearing housing and the connector-ring end shield

In order to obtain correct air gaps, the following operations are necessary:  
Stick three feeler gauges between stator and rotor, thickness 0.2 mm.  
Using a screwdriver, position 4 fastening screws (arrows), then tighten cross-wise to a tightening torque of 4.1 ... 5.5 Nm.

**C12**

Assembling the alternator

0 120 488 ..



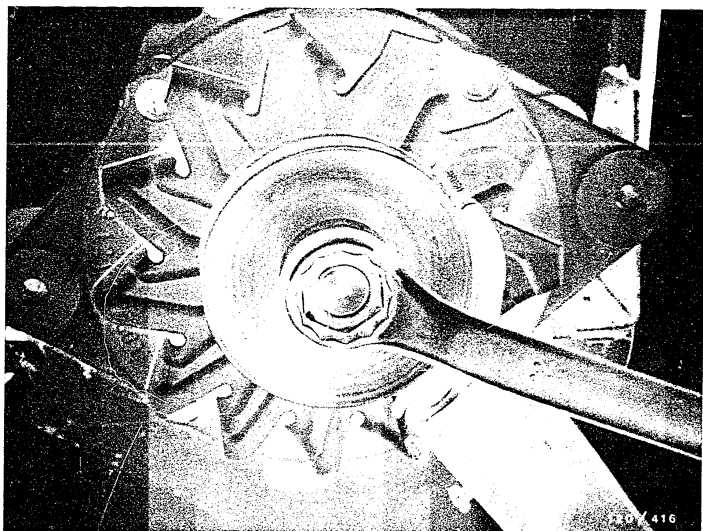

### Mounting the fan

Place Woodruff key in groove. Slip new fan, right way round, onto shaft.

Mount parts of pulley in correct sequence on shaft.  
Tighten the pulley using locking device KDLI 6006 and 22 mm box wrench.

Tightening torque: 35 ... 45 Nm.

**C13**

Assembling the alternator

0 120 488 ..



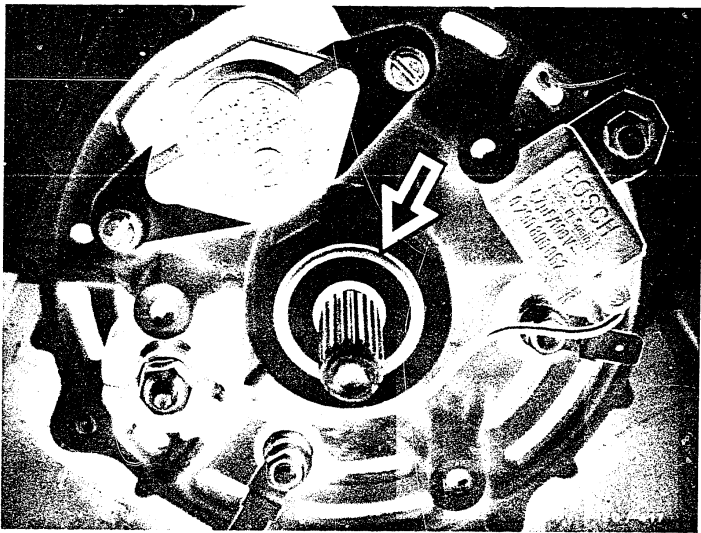

### Installing the regulator and suppression capacitor

Screw the regulator onto the rectifier bearing with 2 fastening screws.

Tightening torque: 1.6 ... 2.3 Nm.

Screw on the capacitor.

Tightening torque: 2.9 ... 4.1 Nm.

Secure the capacitor at B+ terminal stud.

Check O-ring (arrow) for damage, and replace if necessary.



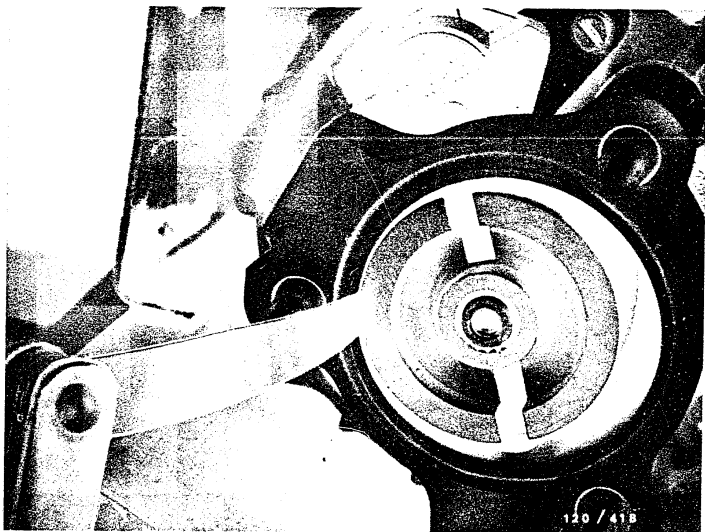

### Mounting the pump housing

Slide the pump housing over the toothed shaft.

Mount rotor on toothed shaft.

Insert feeler gauge with 0.05 mm blade thickness at the narrowest point between rotor and pump housing (see picture). Coat female threads of threaded pins with screw locking paint "precote 80".

Mount pump housing with threaded pins. Tightening torque 6...7 Nm.

Air gap between rotor and pump housing

specified value: 0.05 ... 0.1 mm



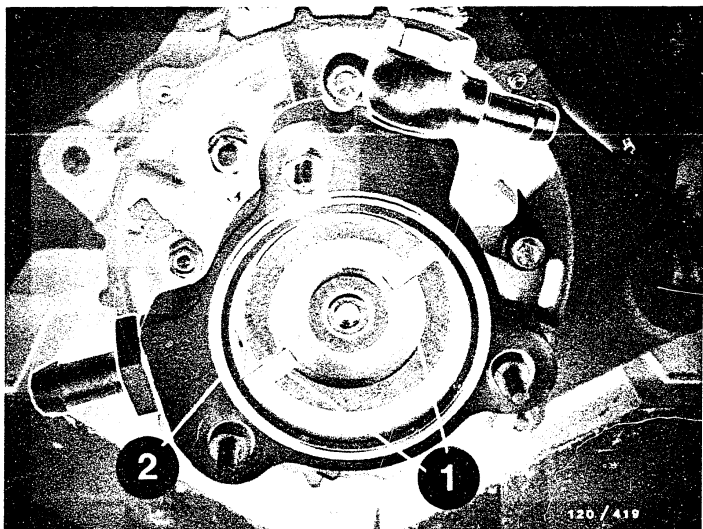

1 = Sliders

2 = O-ring

### Inserting sliders in rotor

In order to guarantee correct seating of the sliders, insert them in as horizontal a position as possible. Check O-ring for damage, and replace if necessary.

**C16**

Assembling the alternator

0 120 488 ..



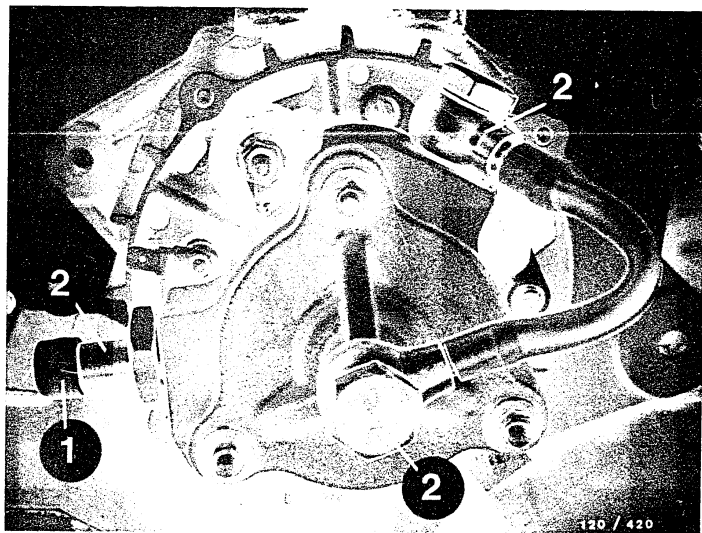

- 1 = Protective cap  
2 = Connection pieces

Mounting the pump housing cover:  
Position the pump housing cover on the pump housing  
and fasten.  
Tightening torque for hexagon nut 4.5...5.5 Nm  
Fit protective cap on connection pieces.

**C17**

Assembling the alternator

0 120 488 ..



11. Testing the alternator with regulator and vacuum pump on test bench

11.1 Test equipment and fixtures

Alternator test bench	or	EFLI 91	0 683 300 100
		EFLJ 70A	0 680 104 ...
Mounting plate for mounting swivel-arm- mounted alternators on alternator test bench		EFLJ 66/3	
		EFLJ 70	
Alternator tester	or	EFAW 192	0 681 101 403
For additional test:		WPG 012.00	0 684 201 200
Ignition oscilloscope		(all models)	
or			
Bosch Motortester		(all models)	
Vacuum tester		ETT 007.00	0 684 100 700
Vacuum reservoir obtainable from: Bitzer GmbH & Co. KG Postfach 240 7032 Sindelfingen		FS 30 (approx. 3 l)	

**D1**

Testing

0 120 488 ..





## 11.2 Mounting on the test bench and connecting (with oil circuit)

Swivel-arm-mounted or flange-mounted alternators must only be mounted on the test bench using the appropriate clamping fixture.

So that the power of the test-bench motor is sufficient, only test using the appropriate fan and pulley. Select the correct transmission ratio.

For test bench EFLJ 70 A the transmission ratio is 0.4:1. This means: If the alternator pulley is, for example, 100 mm  $\emptyset$ , use test-bench pulley with 250 mm  $\emptyset$ .

The charge indicator lamp must be completely out when power-testing.

### Note:

Oil circulation (with engine oil) must be guaranteed throughout the entire power test.

Vacuum connection must be connected to measuring instrument or must be sealed with a protective cap so that no air is drawn in. Without vacuum the pump does not deliver any oil and will then be destroyed.

**D2**

Testing

0 120 488 ..



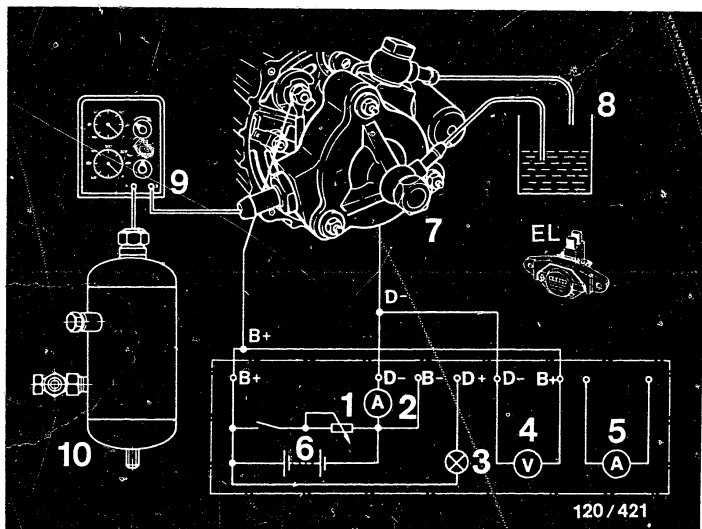

- |                                   |                                 |
|-----------------------------------|---------------------------------|
| 1 = Load resistor                 | 6 = Test bench battery          |
| 2 = Ammeter                       | 7 = Alternator with vacuum pump |
| 3 = Indicator lamp                | 8 = Reservoir with oil          |
| 4 = Voltmeter (regulated voltage) | 9 = Pressure/vacuum tester      |
| 5 = Ammeter                       | 10 = Vacuum reservoir           |

### Connecting the alternator to the test bench

Connect the positive battery cable of the test bench to B+ of the alternator.

If the clamping table on the test bench is used as a ground cable, make sure that there are no contact resistances. It is therefore advisable in the case of high-power alternators to connect the negative battery cable of the test bench directly to the alternator. Connect voltmeter between B+ and B-.

**D3**

Testing

0 120 488 ..



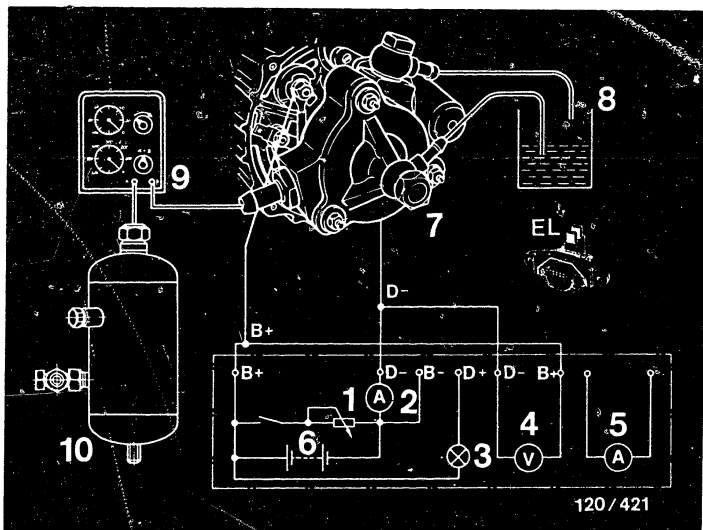

- |                                   |                                 |
|-----------------------------------|---------------------------------|
| 1 = Load resistor                 | 6 = Test bench battery          |
| 2 = Ammeter                       | 7 = Alternator with vacuum pump |
| 3 = Indicator lamp                | 8 = Reservoir with oil          |
| 4 = Voltmeter (regulated voltage) | 9 = Pressure/vacuum tester      |
| 5 = Ammeter                       | 10 = Vacuum reservoir           |

**Important:**

All connections on the test bench must be properly made. When the alternator is running the connection between alternator and battery must not be disconnected since, otherwise, the semiconductors in the alternator and regulator may be destroyed.

Do not operate the alternator without the battery being connected.

If a direction of rotation is marked on the fan wheel or on the alternator, then the alternator must only be driven in this direction of rotation.

**D4**

Testing

0 120 488 ..



### 11.3 Vacuum test:

Connect vacuum connection of vacuum pump to vessel with approx. 3 l air capacity (see test equipment) and to vacuum tester.

Oil circuit for vacuum pump must be guaranteed (see picture for connection). A vessel with approx. 2 l engine oil (e.g. 20 W 50) is sufficient for this purpose.

The end of the intake hose must always be surrounded by oil (no air must be drawn in). Hang the return hose in the vessel such that oil flows back into the reservoir. Bring the alternator to a speed of 2000 min<sup>-1</sup>. After no later than 10 seconds the vacuum tester must indicate 0.7 - 0.8 bar vacuum.

**D5**

Testing

0 120 488 ..



## 11.4 Testing the output

Please note. When testing the output, it is important to see that the rheostat built into the test bench is not switched into the circuit, because otherwise the charge indicator lamp will light up and give the impression that there is a fault in the alternator.

For testing purposes the alternator is brought up to operating temperature on the test bench, approx. 60°C. Select speed of 2000 min.<sup>-1</sup>

### Power test with regulator

Bring alternator to specified test speed. Then adjust load resistor until the specified load is obtained. The indicated voltage must not drop below or exceed 13 V over the entire speed range. Regulator must not be in the tolerance range for the regulated voltage.

### Test specifications:

Alternators 0 120 488 ..	Rotational speed min <sup>-1</sup>	Set load A
000/001 K1(RL) 14V23/65A	1500 2100 6000	23 44 65
002/003 K1(RL) 14V23/55A	1200 1500 6000	10 23 55
004/005 K1(RL) 14V20/45A	1250 1500 6000	10 20 45

**D6**

Testing

0 120 488 ..



### 11.5 Testing the regulated voltage

Bring alternator to rotational speed of 6000 min<sup>-1</sup>.

Load  $\leq$  10 A

Specified value for regulated voltage 13.7 ... 14.5 V

**D7**

Testing

0 120 488 ..



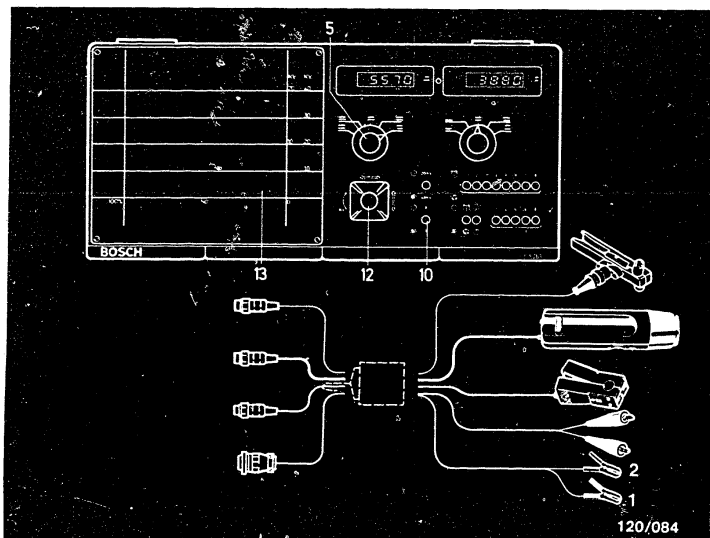

### 11.6 Testing with oscilloscope

Connect oscilloscope (MOT 002.00) to alternator by means of appropriate test lead.

Red clamp (1) to D+ terminal.

Black clamp (2) to B- terminal (ground).

**D8**

Testing

0 120 488 ..



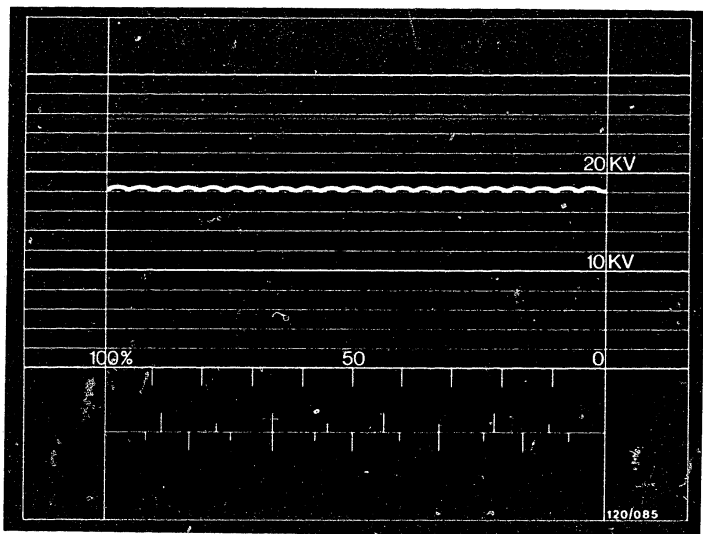

### Adjusting and evaluating the oscilloscope displays

If the alternator is in proper working order, the above display is obtained. The DC voltage supplied has a slight ripple content. The oscilloscope display may have small spikes superimposed on it when the regulator is in operation. The regulator can be "shut down" by connecting in a load (e.g. loading resistor). Adjust the height of the display so that the ripple content is between two kV lines..

In order to compare such displays, the respective display must be adjusted using the vertical controller of the oscilloscope so that it more or less fits in between the 10 and 20 kV lines.

Note: It is also possible for several defects to occur together.







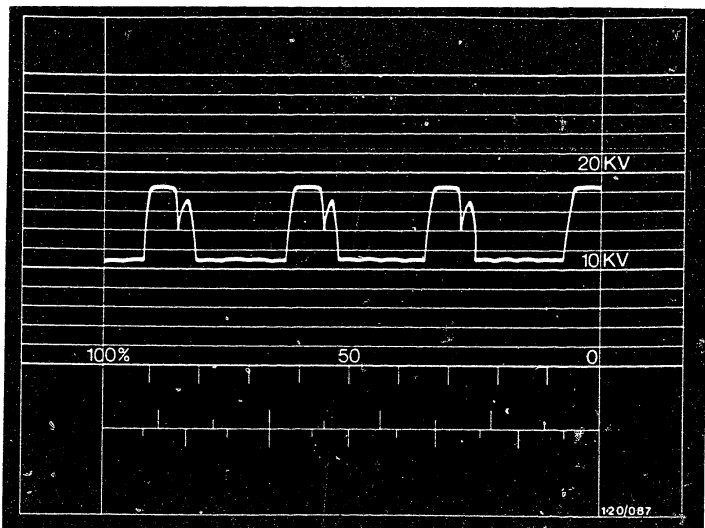

Oscilloscope display shows open circuit in a positive diode

If several diodes are connected in parallel in an alternator, this oscilloscope display only appears when all diodes have an open circuit.

**D11**

Testing

0 120 488 ..



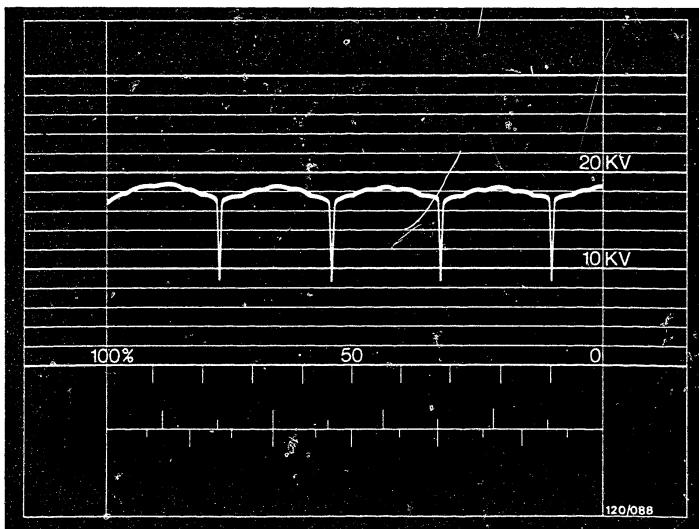

Oscilloscope display shows open circuit in a negative diode

If several diodes are connected in parallel in an alternator, this oscilloscope display only appears when all diodes have an open circuit.

**D12**

Testing

0 120 488 ..



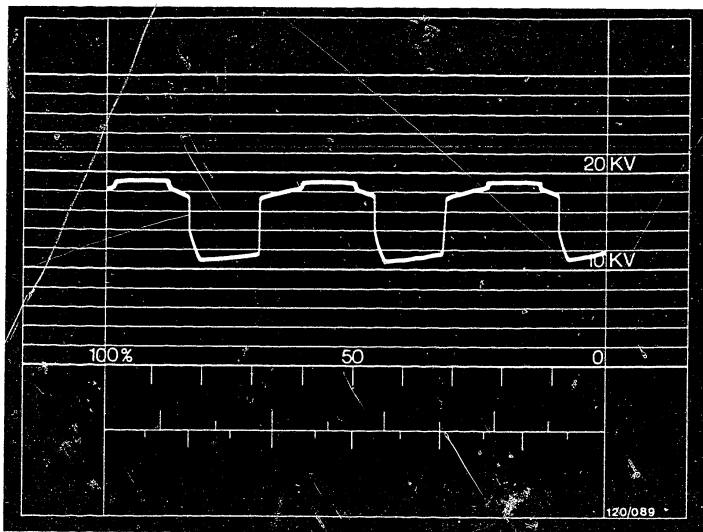

Oscilloscope display shows short circuit in an exciter diode

**D13**

Testing \_\_\_\_\_

0 120 488 ..



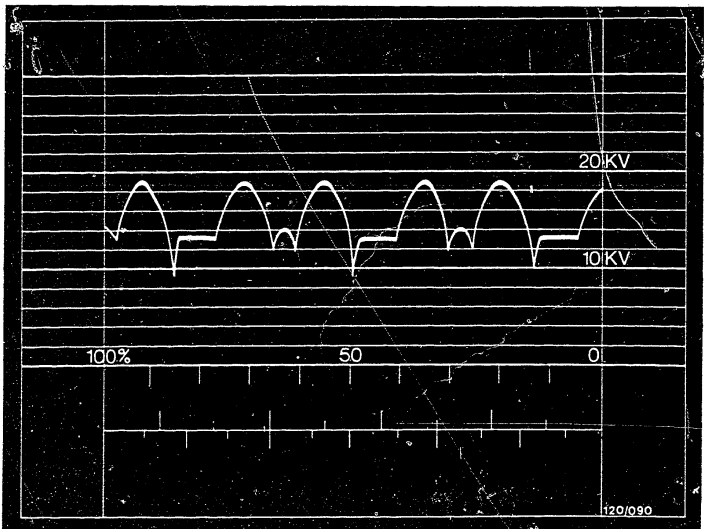

Oscilloscope display shows short circuit in one or more positive diodes.

**D14**

Testing

0 120 488 ..



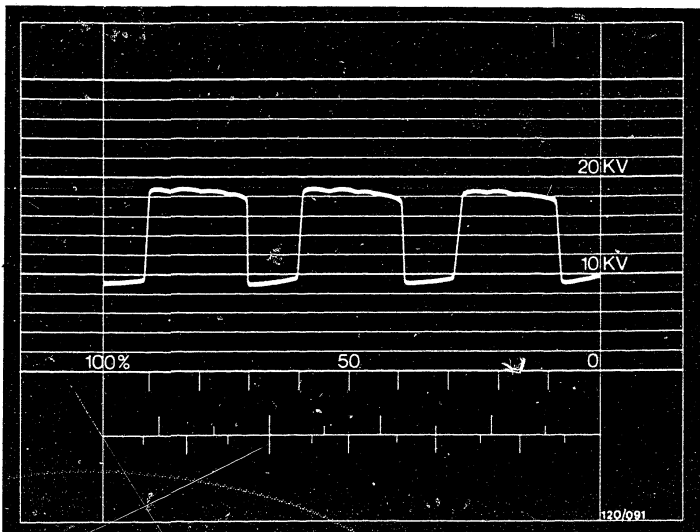

Oscilloscope display shows short circuit in one or diodes.

**D15**

Testing

0 120 488 ..



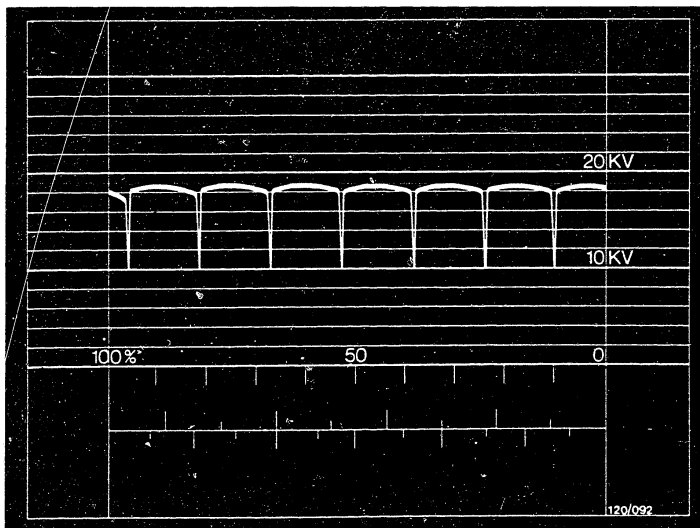

Oscilloscope display shows phase defect (open circuit)

**D 16**

Testing

0 120 488 ..



# After-sales Service

## Technical Bulletin

Only for use within the Bosch organization. Not to be communicated to any third party.

### Parts Cleaning

Use of highly-inflammable cleaning agents, or cleaning agents which are dangerous to health

**Gen.**

VDT-I-Gen./18 En  
7. 1978

When cleaning parts which come from vehicle electrical products prior to repair, it is permitted to use the following cleaning agents: Benzine, trichloroethylene (tri) and perchloroethylene (per). These are dangerous, and must be handled with appropriate care. The relevant safety regulations in West Germany are:

Regulations concerning work with inflammable liquids (VbF) issued by the Federal Labor Ministry (BmÄ).

Safety regulations for the use of chlorinated hydrocarbons  
as applied to the works ZH1/222  
as applied to personnel ZH1/119

as issued by the Federation of the Trade co-operative Associations (Central Association for Accident Prevention and Industrial Medicine) Langartweg 103, D-5300 Bonn 5).

1. Benzine, acetone and ethanol (ethyl alcohol) are inflammable liquids and their mixtures with air are dangerous due to the risk of explosion. Parts washing may only take place in tanks or containers solely intended for this purpose and equipped with a "melt" safety device for the lid which, in case the liquid catches fire, causes the lid to close automatically and smother the fire. In the case of larger containers (exceeding 500 x 500mm) some form of suction extraction must be provided.

- 1.1 Generators, alternators, wiper motors, small-power motors and other electrical equipment for installation in vehicles are, in ever increasing numbers, being equipped with capacitors having long storage times (e.g. for interference-suppression purposes in radio-receiver or transmitter installations).

When washing such parts, it is possible that a capacitor discharge can occur when the part is immersed in the cleaning agent. This can lead to an inflammable liquid catching fire. For this reason, parts on which a capacitor is fitted are only to be washed in trichloroethylene (tri) or perchloroethylene (per).

- 1.2 In the case of starting motors, it has already been pointed out in earlier repair instructions that the parts should be thoroughly dried after washing in benzine, this applies particularly to windings. With sliding-gear starting motors, the first test run after washing out must be performed without the closure cap in order to avoid the possibility of explosion.

**BOSCH**

Geschäftsbereich KH Kundendienst, Kfz-Ausrüstung  
© by Robert Bosch GmbH, D-7 Stuttgart 1, Postfach 50. Printed in the Federal Republic of Germany.  
Imprimé en République Fédérale d'Allemagne par Robert Bosch GmbH.

**N1**

Technical Bulletin

0 120 488 ..





2. Trichloroethylene (tri) and perchloroethylene (per) are both liquids whose vapors have a stupefying effect, and which are dangerous to health if inhaled over long periods. Tri vapor is heavier than air, and therefore especially dangerous at floor level. Gloves and goggles are to be worn when washing out parts in these liquids.

If cleaning of parts is carried out regularly, or continuously, in trichloroethylene only containers or tanks intended solely for this purpose are to be used, and the suction extraction device is to be switched on. When washing parts do not bend over the container.



# After-sales Service

## Technical Bulletin

Only for use within the Bosch organization. Not to be communicated to any third party.

### Sheet Steel Fans for Alternators of Sizes G and K

12

VDT-I-120/103 B

9.1976

Fan discs, primarily produced from galvanized sheet steel, are subjected to varying loads during operation, the magnitude of which depends on the driving habits of the operator.

Please note that, as a safety measure, when repairing or replacing alternators that have been used for more than 100,000 km or for 2,000 operating hours, new sheet-steel fan discs should be installed.

When doing this, be sure that the direction of rotation of the fan disc, as well as the sequence and position of accessories, are correct.

Tightening torque for the fastening nut: 35 - 45 Nm.

In case of inquiry, please contact your authorized representative.

**BOSCH**

Geschäftsbereich KH Kundendienst, Kfz-Ausrüstung  
© by Robert Bosch GmbH, D-7 Stuttgart 1, Postfach 50 Printed in the Federal Republic of Germany.  
Imprimé en République Fédérale d'Allemagne par Robert Bosch GmbH

**N3**

Technical Bulletin

0 120 488 ..



# After-sales Service

## Technical Bulletin

Only for use within the Bosch organization. Not to be communicated to any third party.

### Steel sheet fan wheels for alternators

Assembly instructions

12

VDT-I-120/103 B

Suppl. 1

7. 1977

#### Summary

When assembling the fan wheel and pulley, attention is to be paid to the correct sequence and position of the accessories, in particular the new supporting plate. See Figs. 1 ... 4 for assembly examples.

#### Details

Since the end of 1976 supporting plate 1 120 140 009 has been mounted between the fan and pulley assembly within the scope of further development for various alternators provided with steel sheet fan wheels.

The outside diameter of this new supporting plate (item a) is 55 mm. The 5 mm wide and approx. 0.3 mm high stamping on the rim presses against the fan. A slotted washer (item b) the pulley itself is mounted directly on the side facing the pulley, depending on the alternator model. Care is to be taken that the 26 mm diameter collar of the slotted washer or pulley presses against the supporting plate.

In the case of steel sheet pulleys a second slotted washer (item c) is mounted between the pulley and spring lock washer. The spring lock washer or spring washer, as well as the fastening nut remain unchanged.

The tightening torque for the entire assembly continues to be 35 ... 45 N.m (approx. 3.5 ... 4.5 kgf.m).

Tool KDLJ 6006 is required to hold the pulley when tightening the nut.

Under the following circumstances should the fan wheel be locked using a screwdriver or similar. Bent or damaged fan blades result in damage to the alternator.

In the case of alternators which are provided with the supporting plate ex-works, this plate must also be installed when repair work is performed. Basic information regarding use is provided by the service part documents and packing notes for service part packages. Supporting plate 1 120 140 009 is included in the scope of delivery of the pulley.

The complete assembly is matched to the alignment of the V-belt. Modifications or assembly errors may cause damage.

**BOSCH**

Geschäftsbereich KH, Kundendienst, Kfz-Ausstattung  
© by Robert Bosch GmbH, D-7 Stuttgart 1, Postfach 50. Printed in the Federal Republic of Germany  
Imprimé en République Fédérale d'Allemagne par Robert Bosch GmbH.

**N4**

Technical Bulletin

0 120 488 ..



Careful replacement of the steel sheet fan wheel when repairing or exchanging the alternator after operating for more than 100 000 km or 2000 running hours is still required.

Assembly examples for supporting plate 1 120 140 009

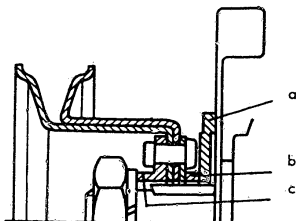

Fig. 1 Single-piece steel sheet pulley with deep hub

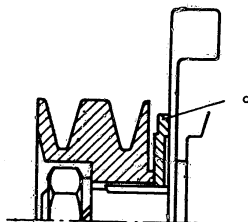

Fig. 2 Solid single-piece pulley

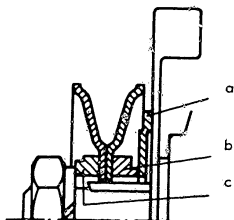

Fig. 3 Two-piece steel sheet pulley

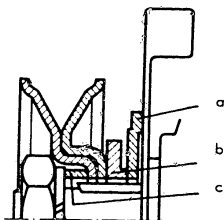

Fig. 4 Offset two-piece steel sheet pulley

Designation of individual components

- a Supporting plate 1 120 140 009
- b Rear slotted washer
- c Front slotted washer



# After-sales Service

## Technical Bulletin

Only for use within the Bosch organization. Not to be communicated to any third party.

ALTERNATORS 0 120 ..

12

VDT-I-120/107 En

9.1979

Alternator operation without battery

### General

Unless special measures are taken, alternators are not to be operated without the battery connected because otherwise this can lead to the destruction of semiconductor components in the regulator, alternator or vehicle electrical system.

In the case of special-purpose vehicles, auxiliary or stationary equipment, or vehicle export, it can be necessary for the alternator to operate without battery - with or without power output.

With systems where the regulator is mounted separately from the alternator, the alternator is placed out of operation before starting by open-circuiting the line between it and the regulator. Power output is now impossible.

This method cannot be used with systems having an attached-type regulator. In such cases, the following methods are used. Details can be taken from the product specifications.

#### 1. Systems with increased voltage-proof characteristics

A variety of vehicle manufacturers order such systems because during shipping it can occur that operation takes place without battery. In such exigencies, power output is possible depending upon alternator speed. These measures protect the alternator and regulator but not the loads.

#### 2. Zener diode 1 127 328 .. for 14 V alternators and max. 35 A

This Zener diode is connected to Terminal B+ of the alternator. If the voltage rises above the response voltage of the Zener diode this conducts and the voltage peak is conducted away through the diode heat sink to the alternator housing. In this way semicon-

**BOSCH**

Geschäftsbereich KM Kundendienst, Kfz-Ausrüstung  
c/o Robert Bosch GmbH, D-7 Stuttgart 1, Postfach 50 Printed in the Federal Republic of Germany  
Imprimé en République Fédérale d'Allemagne par Robert Bosch GmbH

**N6**

Technical Bulletin

0 120 488 ..



ductors in the alternator and regulator are protected against voltage peaks and if necessary the system can deliver power. If required, this Zener diode can be fitted as series equipment on new alternators or can be retro-fitted. Connection in parallel or series of these Zener diodes for the purpose of increasing the power is not possible.

Notes on testing are contained in Instructions VDT-W-120/300.

Burnt-out connections between Zener diode and alternator B+ are the result of false polarity during battery change, use of auxiliary starting aids or operation with 24 V etc. Warranty claims are therefore to be rejected.

### 3. Systems with over-voltage protection devices fitted

For years, such devices (OSG) have been available either integrated in the regulator e.g. 0 192 083 .. or separate 0 192 900 .. for use in 28 V systems.

When voltages occur in excess of the OSG response voltage, the Terminals D+ and D- are connected together by the OSG. The alternator is short-circuited and cannot self-excite. This means that resultant damage in the vehicle electrical system due to excessive alternator voltage is avoided.

As long as the OSG does not conduct, without battery connected, the alternator can deliver power.

### 4. Short-circuit capsule 1 120 505 000 for K1, N1 and T1 alternators

In order that the alternator does not self-excite during operation without battery, Terminals D+ and D- are connected together. At customer request, certain alternator models are equipped at the works with a short-circuit capsule connected to Terminal D+ for this reason. This enables engines and vehicles to be tested on dynamometers etc. without the battery being connected. Power cannot be taken from the alternator.

After the battery is connected the capsule is removed so that the system is ready for operation. If, subsequently, operation without battery is required, D+ and D- must be connected together again.

Details regarding the Part Numbers of the products dealt with in this Bulletin can be requested from your local Bosch representative.



# After-sales Service

## Technical Bulletin

Only for use within the Bosch organization. Not to be communicated to any third party

ADDITIONAL IDENTIFICATION OF  
ALTERNATORS 0 120 ..

VDT-I-120/116 En  
4.1981

Since date of manufacture FD 143 (March 1981) the alternators fitted with stick-on nameplates have received an additional identification. This takes the form of stamping the last 4 figures of the appropriate part number on a suitable place on the front of the collector-ring end shield. The figures are 4 mm high. The exterior characteristics of the alternators make it possible to find out the remaining 6 figures of the part number.

Since the introduction of this additional identification, the part number of an alternator can be ascertained even if the nameplate is missing or has become illegible. This makes it easier to find technical data in such cases, as well as to quote the full part number in correspondence or in guarantee claims.

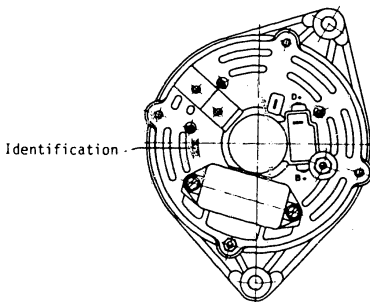

**BOSCH**

Geschäftsbereich KH Kundendienst Kfz-Ausrüstung  
© by Robert Bosch GmbH, D-7 Stuttgart 1, Postfach 50 Printed in the Federal Republic of Germany  
Imprimé en République Fédérale d'Allemagne par Robert Bosch GmbH

**N8**

Technical Bulletin

0 120 488 ..



## Table of contents

<u>Section</u>	<u>Coordinate</u>
Structure of microfiche.....	A 1
1. Special features.....	A 2
2. Test specifications - electrical.....	A 3
3. Test specifications - mechanical.....	A 6
4. Circuit diagram of alternator.....	A 9
5. General information.....	A 11
6. Test equipment, tools and adhesives.....	A 14
7. Exploded view.....	A 18
8. Dismantling the alternator and checking the parts.....	B 1
8.1 Testing the suppression capacitor.....	B 1
8.2 Checking the regulator for external damage and replacing the carbon brushes....	B 3
8.3 Testing the rectifier.....	B 9
8.4 Testing the stator (resistance).....	B 10
8.5 Testing the stator (short circuit to ground).....	B 12
8.6 Testing the rotor resistance.....	B 17
8.7 Testing the rotor for short circuit to ground.....	B 18
8.8 Measuring the true-running error.....	B 20
9. Cleaning the parts.....	C 1
10. Assembling the alternator.....	C 2





## Table of contents (continued)

Section	Coordinate
11. Testing the alternator with regulator and vacuum pump on test bench.....	D 1
11.1 Test equipment and fixtures.....	D 1
11.2 Mounting on the test bench and connecting (with oil circuit).....	D 2
11.3 Vacuum test.....	D 5
11.4 Power test.....	D 6
11.5 Testing the regulated voltage.....	D 6
11.6 Testing with oscilloscope.....	D 7
Technical Bulletins.....	N1

©1984 Robert Bosch GmbH  
Automotive Equipment - After-Sales Service  
Department for Technical Publications KH/VDT,  
Postfach 50, D-7000 Stuttgart 1

Published by: After-Sales Service Department for  
Training and Technology (KH/VSK). Press date: 9.1984  
Please direct questions and comments concerning the  
contents to our authorized representative in your  
country.

This publication is only for the use of the Bosch  
After-Sales Service Organization, and may not be  
passed on to third parties without our consent.

Microfilmed in the Federal Republic of Germany. Micro-  
photographié en République Fédérale d'Allemagne.

